

Keysight Technologies

Power Meters and Power Sensors

High Performance Solutions for Peak and Average Power Measurements





Introducing Keysight Power Meters and Sensors

Reliable, high-performing solutions

Every power meter and sensor from Keysight Technologies, Inc. consistently delivers great results.

A sure investment for many years to come

Code-compatibility between power meters reduces the need for re-coding. Not only that, all Keysight power meters are backward-compatible with most legacy power sensors.

One specific application: One right solution

Keysight offers a wide selection of power meters and sensors for practically all application needs—wireless communications, radar pulse measurements, component test and more.

Global network support

No matter where you are, Keysight is committed to giving you the 24-hour support you need regarding our products, applications or services.

Table of Contents

Peak Power Measurements and Analysis	3
For Faster Measurement Speed and Greater Measurement Accuracy	3
Peak and Average Power Measurements	6
For Wireless and Radar Applications	6
For Accelerated Production Throughput	9
For Compact ATE Systems	12
For Effective Capture of Wireless Signals	15
For Testing of Complex Modulation Formats	19
Average Power Measurements	22
For Metrology and Calibration Laboratories	22
For Flexible Testing: On the Rack and On the Go	23
For Mobile Testing that's Plug-and-Play Easy	25
For Improved Power Measurement Throughput	28
For Portable RF Measurements	30
Power Measurement Software	31
For Easy Monitoring and Troubleshooting	31
For Simplified Data Capture	32
Power Meters Selection Chart for Wireless Communication	33
Power Sensors Selection Chart for Wireless Communication	35
Power Meters and Sensors Compatibility Table	36
Related Keysight Literature	38
Warranty Information	39
Contact Keysight	

Peak Power Measurements and Analysis For Faster Measurement Speed and Greater Measurement Accuracy

Keysight 8990B peak power analyzer

The 8990B peak power analyzer comes with two RF channels and two video channels and, when used with a compatible power sensor, measures the dynamic time-dependent aspects of RF and microwave power. Combined with the N1923A/N1924A wideband power sensors, the 8990B achieves 5 nano seconds RF pulse rise time/fall time. The 8990B provides internal and external trigger functions and the peak power analyzer's video input allows for the simultaneous analysis of time-domain control signals.

Designed with both ease of use and high performance in mind, the 8990B peak power analyzer does more than just measure and analyze – it saves you time and effort, letting you focus on the important details.

The 8990B peak power analyzer has been named one of *Test & Measurement World's* Top 50 products for 2011.



Features

Models

- 8990B peak power analyzer

Specifications

- 160 MHz video bandwidth
- 100 Msamples/s continuous sampling rate

Measurement type

- Peak, average, peak-to-average ratio power measurements
- CCDF statistical analysis in graphical and tabular formats
- Rise time, fall time, pulse width, duty cycle, PRI and PRF
- Automated delay measurement, automated droop measurement, pulse spacing measurement
- Multi-pulse analysis (with option 8990B-1FP or N6903A)
- Power-added efficiency (PAE) measurement

Calibration

- Calibration and correction factors in EEPROM (N1923A/N1924A wideband power sensors and P-Series power sensors)
- Internal zeroing and calibration (N1923A/N1924A wideband power sensors and P-Series power sensors)

Remote programmability

- SCPI standard interface command
- LAN and USB interfaces
- GPIB (with N4865A GPIB to LAN adapter)

Highlights

- Achieve 5 nano-second rise time/fall time – the fastest in the peak power measurement market
- Set, trigger and measure pulse measurements easily
- Perform accurate and more detailed pulse measurements, faster
- Verify design problems quickly with a 15-inch XGA color display
- Compatible with U2000 Series USB power sensors for additional channels

Peak Power Measurements and Analysis For Faster Measurement Speed and Greater Measurement Accuracy (continued)

Delay measurement

Perform delay measurements by pressing the Delay Measurement button on the soft panel key and two vertical markers will automatically detect the first pulse of the traces. The time delay between the two traces will be displayed in the measurement panel below the graphical window.

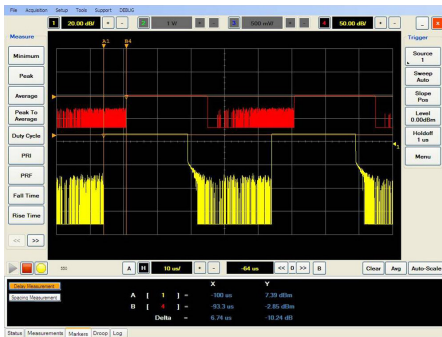

Drop measurement

The 8990B is the first peak power analyzer on the market to offer automated Pulse Droop measurement, which measures the amplitude degradation of the pulse top. This eliminates the need to manually manipulate the horizontal markers to make this measurement. Access the Pulse Droop measurement via the soft panel key.

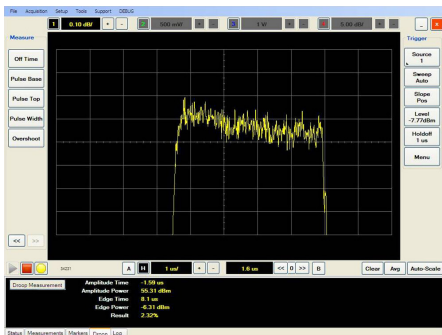

Multi-pulse measurement

The multi-pulse measurement feature adds pulse-to-pulse measurement and histogram graph capabilities to the 8990B, and allows users to continuously trigger and capture up to 512 pulses. Additionally, users can use the multi-pulse feature to analyze short pulses with long off-times or the amplitude droop across the pulse train.

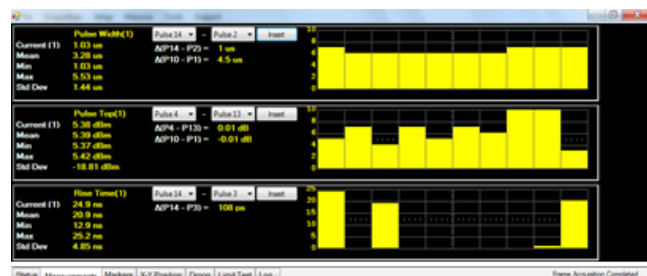
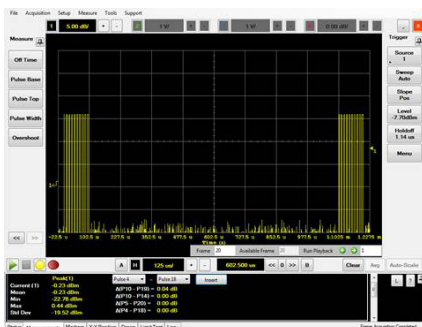

Peak Power Measurements and Analysis For Faster Measurement Speed and Greater Measurement Accuracy (continued)

Power-added efficiency math function

Calculate the power-added efficiency (PAE) of power amplifiers and display instant PAE traces onscreen with the 8990B. The peak power analyzer's two RF input channels allow users to measure the RF power gain from the power amplifier; using a DC current probe, scope probe or differential probe, they can also measure the power amplifier's voltage and current through the analog video input channels. The 8990B's PAE math function then uses these measurements to easily determine the PAE percentage of the power amplifier.

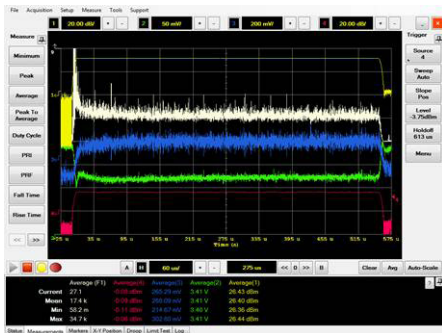

Compatible power sensors/software



N1923A wideband power sensor (50 MHz to 18 GHz; -35 dBm to +20 dBm)
N1924A wideband power sensor (50 MHz to 40 GHz; -35 dBm to +20 dBm)



P-Series power sensors (50 MHz to 40 GHz; -35 dBm to +20 dBm)



USB power sensors (using N1918A Power Analysis Manager software or BenchVue software)

Frequency and power ranges are wider with options. Please visit our Web site at www.keysight.com/ind/powermeters to find out the options available for each sensor.

Peak Power Measurements and Analysis For Wireless and Radar Applications

Keysight U2040 X-Series Wide Dynamic Range Power Sensors

Accurately measure any modulated signal with the U2040 X-Series power sensors. With LAN connectivity, a first in the industry, and USB connectivity, the U2040 X-Series comes with the world's widest dynamic range in a power sensor, covering a range of -70 to +26 dBm. And because the U2049XA LAN power sensor comes with a thermal vacuum option, you can get the same accuracy and performance even in thermal vacuum chambers.

Features

Models

- U2041XA USB wide dynamic range average power sensor (10 MHz to 6 GHz; -70 dBm to +26 dBm)
- U2042XA USB peak and average power sensor (10 MHz to 6 GHz; -70 dBm to +26 dBm)
- U2043XA USB wide dynamic range average power sensor (10 MHz to 18 GHz; -70 dBm to +26 dBm)
- U2044XA USB peak and average power sensor (10 MHz to 18 GHz; -70 dBm to +26 dBm)
- U2049XA LAN wide dynamic range power sensor (10 MHz to 33 GHz; -70 dBm to +20 dBm)



Specifications

- Measurement speed: 50,000 readings/second (fast/buffered mode)
- Sampling rate: 20 MSamples/second

Measurement type

- Peak, min, average, and peak-to-average ratio power measurements
- Time-gated and free-run measurement modes
- Automatic rise time, fall time, pulse width, pulse period, duty cycle, time to positive occurrence, and time to negative occurrence time measurements

Calibration

- Internal zeroing and calibration

Remote programmability

- USB interface
- LAN interface

Highlights

- The world's widest dynamic range in a power sensor, spanning -70 to +26 dBm
- Fast measurement speed at 50,000 readings/second (fast/buffered mode)
- Average mode time selectivity feature allows the sensor to make both average and time-gated average measurements across the full 96 dB range
- Capture and analyze measurements with the intuitive BenchVue software
- World's first LAN-based sensor with thermal vacuum option

Peak Power Measurements and Analysis For Wireless and Radar Applications (continued)

Typical test setup for wireless chipset manufacturing test

Three power sensors are used to measure the chipset's input power, output power, and reflected power. A spectrum analyzer, like the Keysight Technologies MXA, is used to measure other critical parameters such as ACPR, EVM, and harmonics. Care should be taken to ensure that the power to be measured does not exceed the sensor's measurable power range in order to avoid damaging the sensor, particularly at the power amplifier's output. Depending on the signal formats, a trigger output signal from the signal source can be connected to the trigger input ports of the power sensors in order to synchronize the signal timing and sensors' measurement acquisitions.

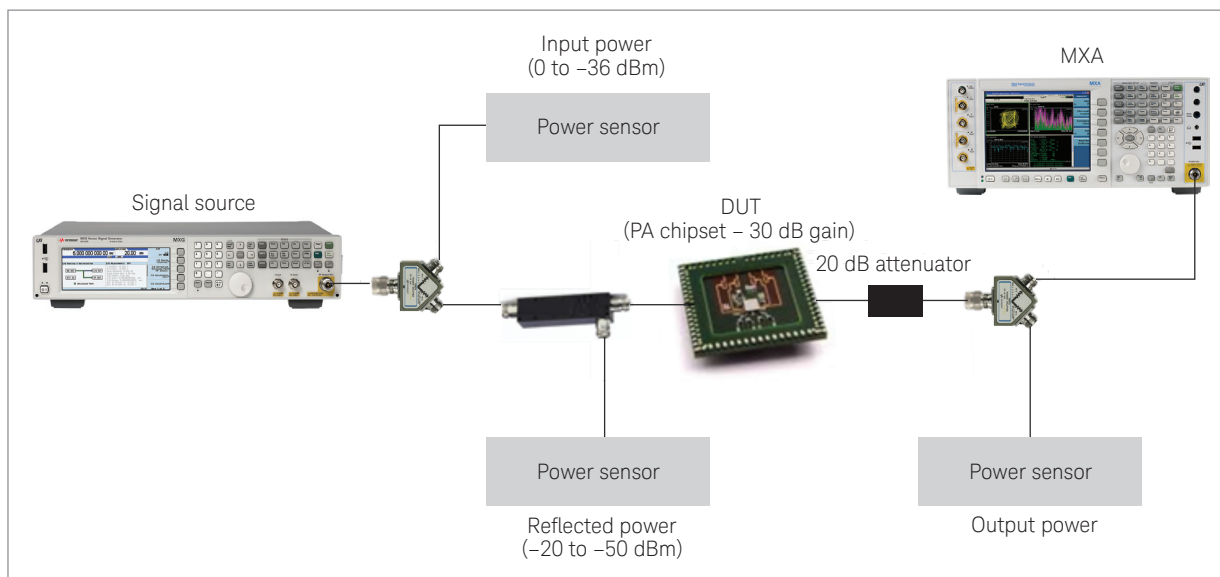

Wireless manufacturing setup

Average mode time-selectivity measurement

The average mode time-selectivity feature allows you to configure the aperture duration of measurement capture with reference to the immediate trigger or external trigger. The aperture duration is settable from 20 μ s to 200 ms with a resolution of 100 ns – a resolution low enough to cover any radio format. This new feature allows you to control which portion of the waveform is measured, giving you the same results as those provided by time-gated power measurements made in peak mode. The key benefits of this feature are that it enables the sensor to perform both waveform average and time-selectivity average power measurement across the full 96 dB of dynamic range, and offers real time measurements of up to 50,000 readings per second.

Peak Power Measurements and Analysis For Wireless and Radar Applications (continued)

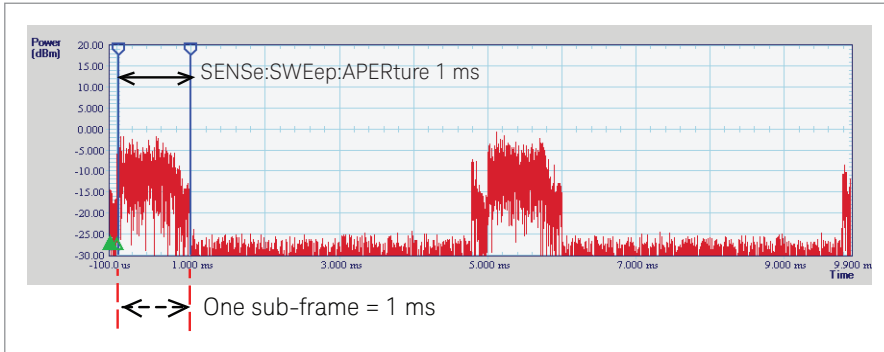

Measurement results for one 1 ms LTE sub-frame using burst average power setting.

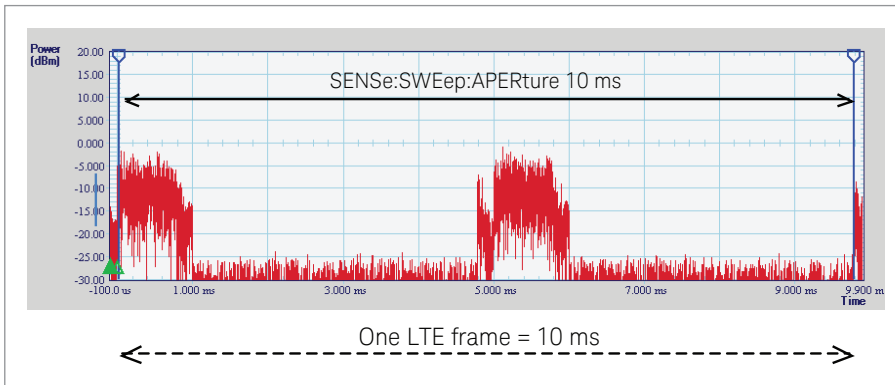

Measurement of one LTE frame over 10 ms using waveform average power setting.

U2040 X-Series sensor settings for wireless tests

In order to achieve the most accurate and fastest measurements, the U2040 X-Series can be configured into different modes based on the signal formats. The following table lists the common wireless signal formats and the recommended sensor settings.

Type of measurement	Signals	Recommend sensor settings
Burst average power for signals with burst/frame structure	LTE-TDD, GSM, EDGE, WLAN	Average mode time-selectivity
Waveform average power for signals with burst/frame structure	LTE-TDD, GSM, EDGE, WLAN	Average mode time-selectivity
Waveform average power for continuous modulated signals	W-CDMA, LTE-FDD	Free run, fast mode
Time slotted signals without external trigger signals	GSM, EDGE	Normal mode time-gated power measurement
Time slotted signals with external trigger signals	GSM, EDGE	Normal mode time-gated power measurement, or Average mode time-selectivity

Compatible power sensors/software



BenchVue software (version 2.6 and above)

Peak and Average Power Measurements and Analysis For Accelerated Production Throughput

Keysight U2020 X-Series USB peak and average power sensors

The U2021XA and U2022XA X-Series USB peak power sensors are designed to carry out high speed peak and average power measurements. These sensors offer a fast measurement speed of > 3500 readings/second and a wide peak power dynamic range of -30 dBm to +20 dBm, providing the peak power measurement capability of a power meter in a compact, portable form.

Features

Models

- U2021XA X-series USB peak and average power sensor (50 MHz to 18 GHz; -35 dBm to +20 dBm)
- U2022XA X-series USB peak and average power sensor (50 MHz to 40 GHz; -35 dBm to +20 dBm)

Specifications

- 30 MHz video bandwidth
- > 25,000 readings/s measurement speed (in buffer mode)
- Frequency range of 50 MHz to 18 GHz/40 GHz

Measurement type

- Peak, min, average, and peak-to-average ratio power measurements
- Time-gated and free-run measurement modes
- Automatic rise time, fall time, pulse width, pulse period, duty cycle, time to positive occurrence, and time to negative occurrence time measurements
- CCDF statistical analysis

Calibration

- Internal zeroing and calibration

Remote programmability

- USB interface



Highlights

- Fast measurement speed of > 25,000 readings/second (in buffer mode)
- Wide peak power range of 50 dB, ranging from -30 dBm to +20 dBm
- Fast rise/fall time of down to 13 nano seconds and a video bandwidth of 30 MHz
- Standalone peak power measurement capability without the need of a power meter
- Built-in trigger in/trigger out function
- Built-in radar and wireless presets

Peak and Average Power Measurements and Analysis For Accelerated Production Throughput (continued)

High throughput wireless test systems with up to 20 channels

The U2020 X-series USB peak and average sensors perform fast and accurate peak and gated power measurements. These measurements are essential aspects of the production tests conducted for wireless signals used in cellular/mobile phone handset, wireless chipset and amplifier applications. With plug-and-play USB connectivity, high measurement speed and multichannel capability, setting up a high throughput test system is simple, fast and cost effective.

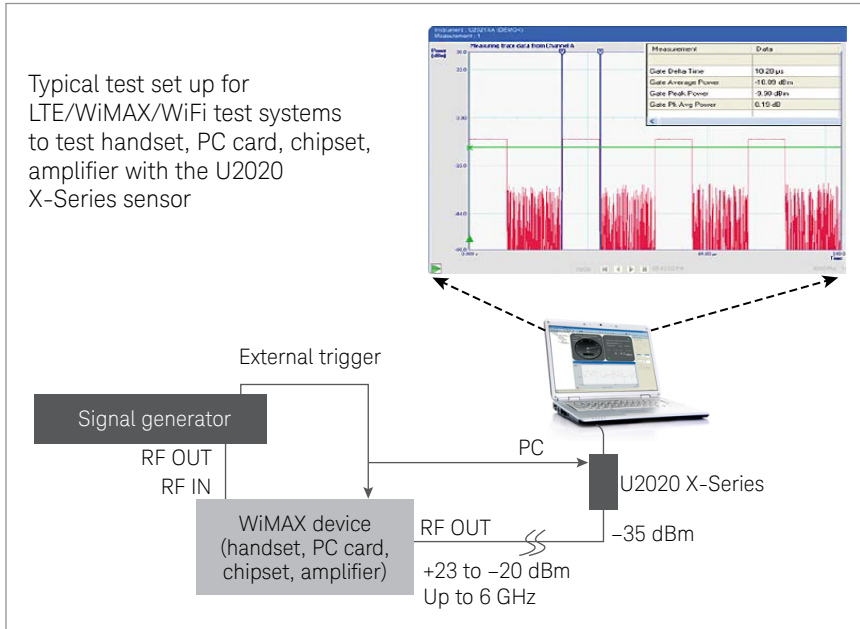

Remote testing for radar installation and maintenance

When a U2020 X-series sensor is connected to a LAN-USB adapter, you can perform complex radar pulse analysis and monitor your measurements from a distance up to 200 feet. The built-in internal zero calibration function allows you to permanently connect your sensor to the device-under-test without the hassle of constantly removing and re-installing your sensor.

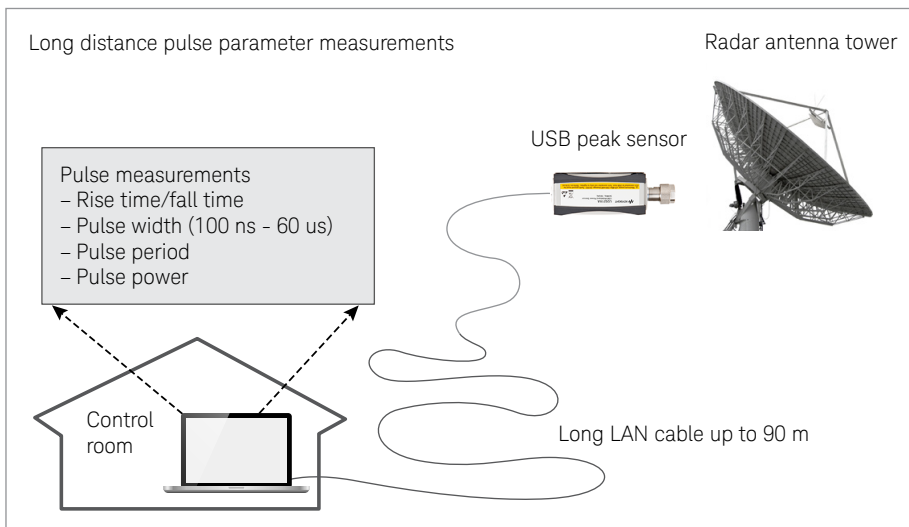

Peak and Average Power Measurements and Analysis For Accelerated Production Throughput (continued)

Portable solution for base station installation and maintenance

Portability is one of the key attributes in the base station installation and maintenance industry, where users mainly work out in the field. Whether you are using a PC or other Keysight instruments, the U2020 X-series USB power sensors will perform peak and average power measurement similar to traditional power meters, all in a portable and lightweight form factor.

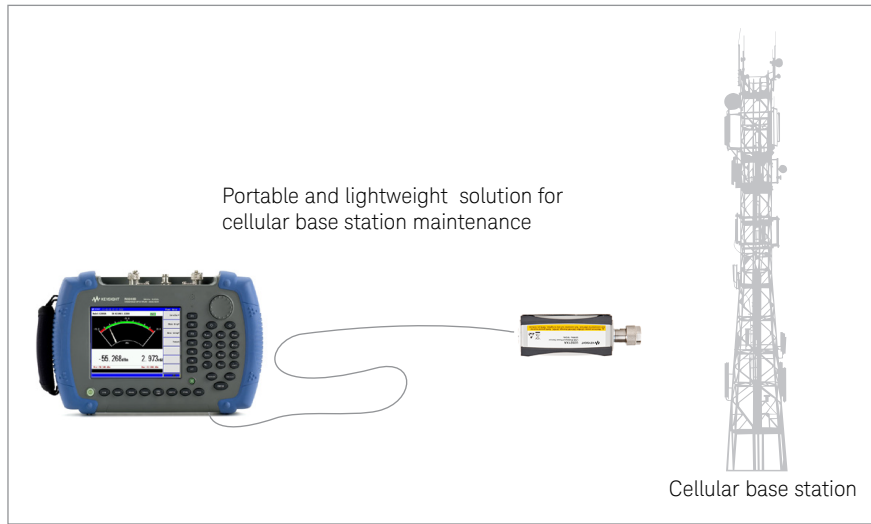

Compatible power sensors/software



N1918A Power Analysis Manager software



BenchVue software (version 2.5 and above)

Peak and Average Power Measurements For Compact ATE Systems

Keysight N8262A P-Series modular power meter

The N8262A is a dual-channel, LXI Class C compliant power meter that's designed to support LAN-based ATE systems. With its slim, half-rack build, the N8262A enables a smaller test system and ensures easier deployment.

Features

Dimension

- 1U half-rack size

Specifications

- 30 MHz video bandwidth
- 100 Msamples/s continuous sampling rate

Measurement type

- Peak, average, peak-to-average ratio power measurements
- Time-gated and free-run measurement modes
- CCDF statistical analysis
- Rise time, fall time, pulse width, time to positive occurrence and time to negative occurrence measurements
- Includes predefined configurations for WLAN, radar and MCPA

Calibration

- Calibration and correction factors in EEPROM (P-Series, E-Series sensors)
- Internal zeroing and calibration (P-Series sensors) * Refer to page 18

Remote programmability

- SCPI standard interface command
* Also programmable in other languages. See "System-ready software" below.
- 10/100BaseT LAN interface

System-ready software

- Bundled Synthetic Instrument Finder works with all LXI-compliant instruments
- Instrument Web page is accessible with any standard Web browser
- Bundled Power Meter GUI is also compatible with P-Series power meters
- Bundled IIVI driver enables programming in your choice of environment, including Keysight VEE, LabVIEW, C, C#, C++, Microsoft Visual Basic, and MATLAB

Backward-compatibility

- Code-compatible with N1912A P-Series power meter



Highlights

- Deploy test systems more easily
- Lower test system startup cost
- Integrate easily into existing systems
- Perform remote access and control from anywhere

Peak and Average Power Measurements For Compact ATE Systems (continued)

Deploy test systems more easily

With its 1U half-rack size, the N8262A eases deployment of test systems wherever duty calls.

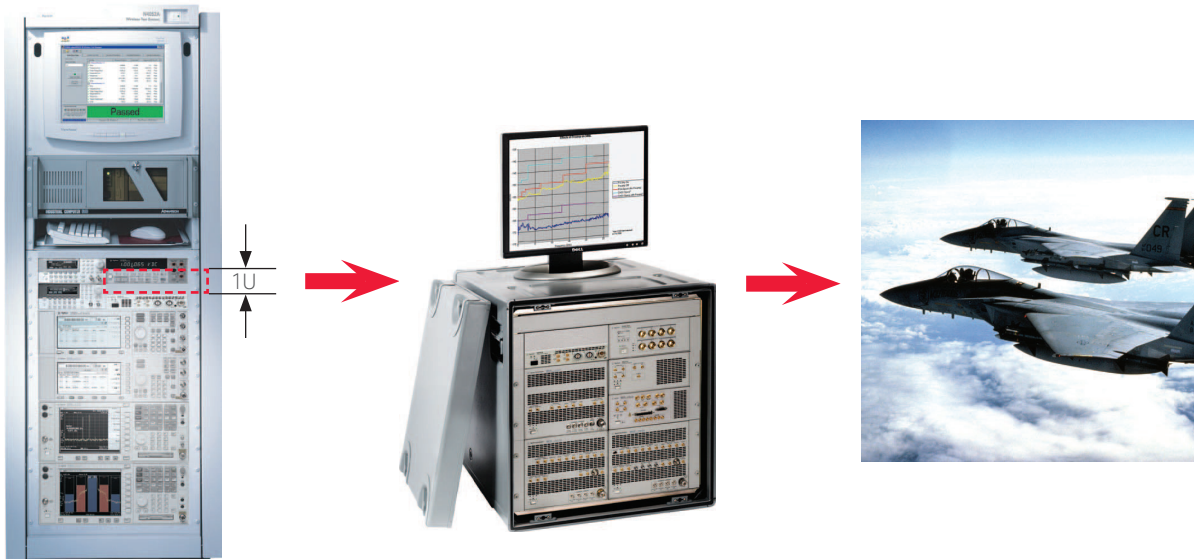

Smaller test systems are possible with the 1U N8262A, making it more readily deployable

Integrate easily into an existing system at a lower startup cost

The N8262A can operate without imposing expensive overhead—from cardcages, system controllers or power supplies—on your test system. Once an N8262A is detected on the network, you can access and configure its settings through any standard Web browser, and start measurements right away with the bundled Power Meter GUI soft front panel. With programming flexibility, use your preferred programming language (including SCPI, Keysight VEE and C) instead of spending time re-coding in an unfamiliar language.

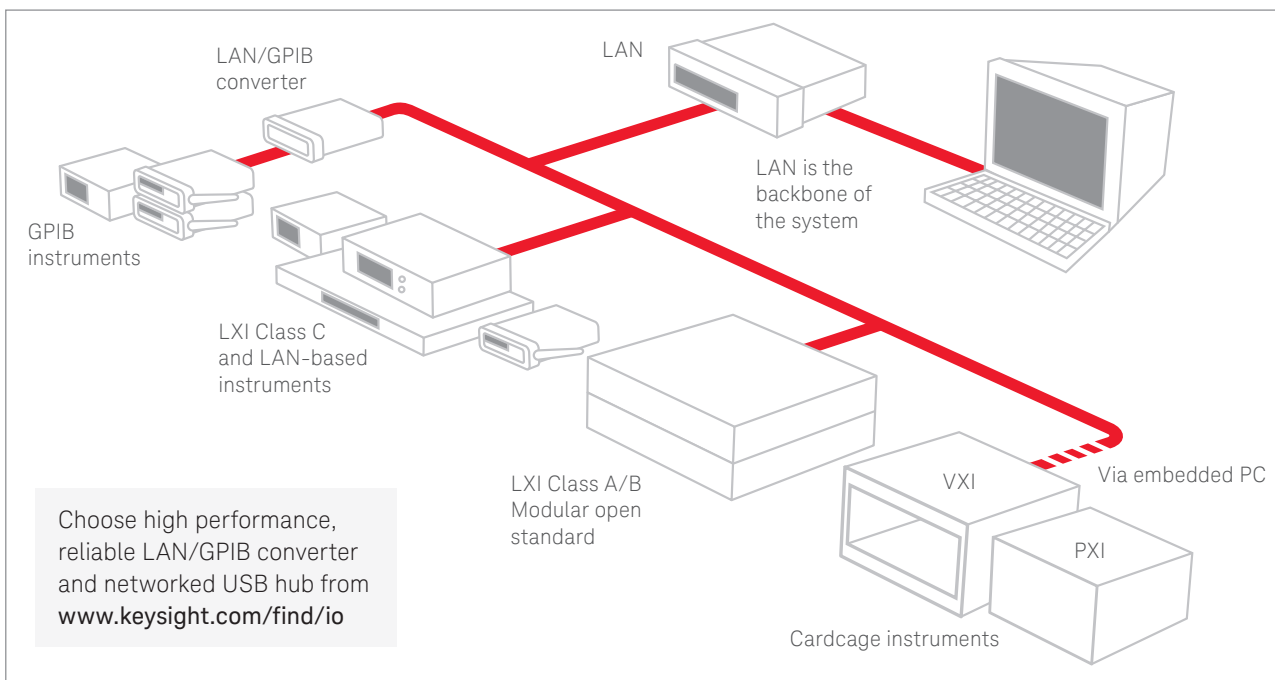

Peak and Average Power Measurements For Compact ATE Systems (continued)

Remote access and control from anywhere

With the convenience of LAN, neither place nor distance is a limit to power measurements with the N8262A.

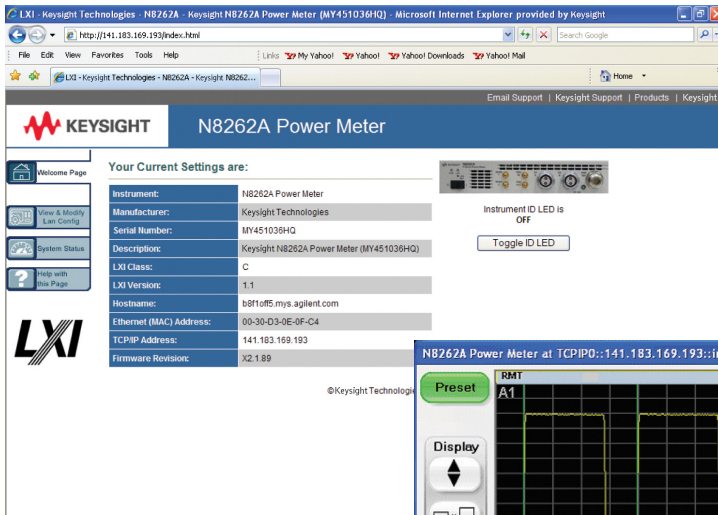

Whenever you need to view or modify an N8262A's current proxy settings, you can do so with its built-in Web page.

Control an N8262A and view measurement results through the Power Meter GUI soft front panel, the way you would a P-Series power meter from its front panel.

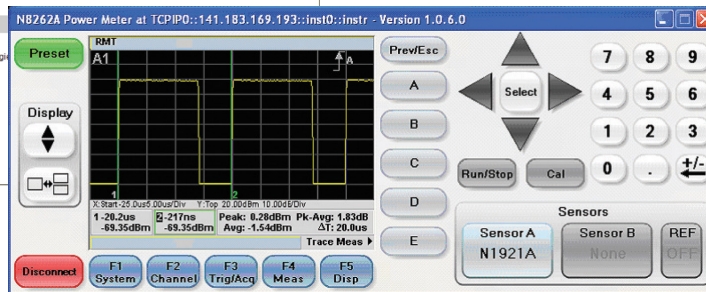

Compatible power sensors/software



P-Series power sensors (50 MHz to 40 GHz; -35 dBm to +20 dBm)



E9320 E-Series power sensors (50 MHz to 18 GHz; -65 dBm to +20 dBm)



E4410 and E9300 E-Series power sensors (9 kHz to 26.5 GHz; -70 dBm to +44 dBm)



N8480 Series thermocouple and waveguide power sensors (100 kHz to 67 GHz; -35 dBm to +44 dBm)



8480 Series diode, thermocouple and waveguide power sensors (100 kHz to 110 GHz; -70 dBm to +20 dBm)



N1918A Power Analysis Manager software



BenchVue software (version 3.0 and above)

Frequency and power ranges are wider with options. Please visit our Web site at www.keysight.com/find/powermeters to find out the options available for each sensor.

Peak and Average Power Measurements For Effective Capture of Wireless Signals

Keysight N1911A/12A P-Series power meters

The P-Series power meters are LXI Class C compliant, designed for high performance measurement of wireless signals such as WiMAX™ and radar. Predefined settings in the P-Series power meters enable effective capture of unpredictable wireless signals, with their high burst rates and fast, time-varying power levels.

Features

Models

- Single-channel N1911A
- Dual-channel N1912A

Specifications

- 30 MHz video bandwidth
- 100 Msamples/s continuous sampling rate

Measurement type

- Peak, average, peak-to-average ratio power measurements
- Time-gated and free-run measurement modes
- CCDF statistical analysis in graphical and tabular formats
- Rise time, fall time, pulse width, time to positive occurrence and time to negative occurrence measurements
- Includes predefined configurations for WiMAX, HSDPA and DME

Calibration

- Calibration and correction factors in EEPROM (P-Series, E-Series sensors and N8480 Series)
- Internal zeroing and calibration (P-Series sensors) * Refer to page 18

Remote programmability

- SCPI standard interface commands
* Also programmable in other languages. See below
- GPIB, LAN and USB interfaces

System-ready software

- Bundled IVI driver enables programming via your choice of environment, including Keysight VEE, LabVIEW, LabWindows, C, C++, and MATLAB

Backward-compatibility

- Code-compatible with EPM-P and EPM Series power meters

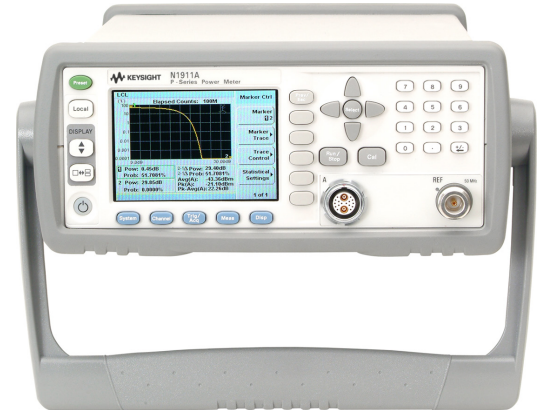

Highlights

- Quick setup with 22 radio presets
- Automatic pulse capture
- Wide VBW and high sampling rate
- High resolution color display
- External triggerable when used with E-Series average power sensors

Peak and Average Power Measurements For Effective Capture of Wireless Signals (continued)

High sampling rate for WiMAX and WLAN testing

Apart from WiMAX and WLAN presets, the P-Series power meters also offer 100 Msamples/s continuous sampling that ensures glitches are not missed.

- The P-Series power meters' 30 MHz wide video bandwidth enables the capture of WiMAX signals
- With their auto trigger hold-off capability, you can capture the complete Downlink or Uplink subframe burst desired within a fixed time span
- Time-gated peak, average and peak-to-average ratio power measurements are automatically displayed to ease analysis of signals

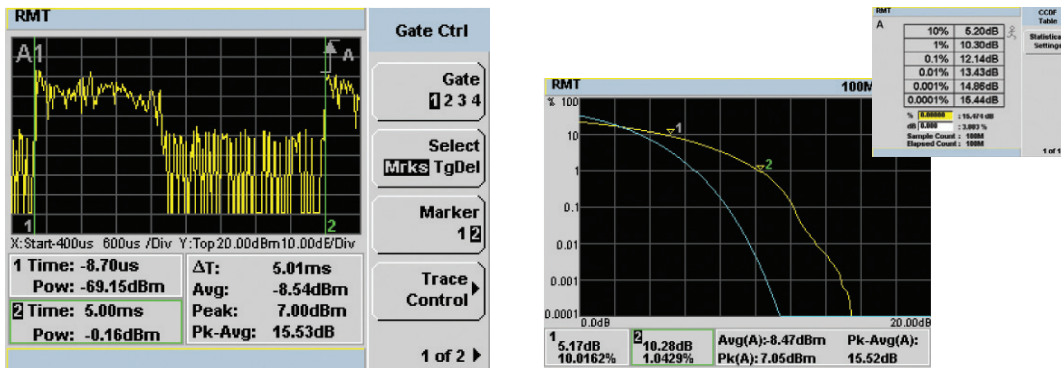

CCDF statistical analysis is viewable in both tabular and graphical formats

Autoscaling and autogating for radar testing

Setting up for radar signal measurements is faster and easier with the P-Series preset. Capture of a radar pulse is further simplified with autoscaling and autogating functions. With autogating set to "perpetually on," the gates reposition themselves automatically when pulse width changes.

- Up to four independent time gates can be set for individual measurements on one or multiple pulses
- With a frequency range of up to 40 GHz and rise/fall times of ≤ 13 ns, you have more than enough to profile high-frequency radar signals in most applications

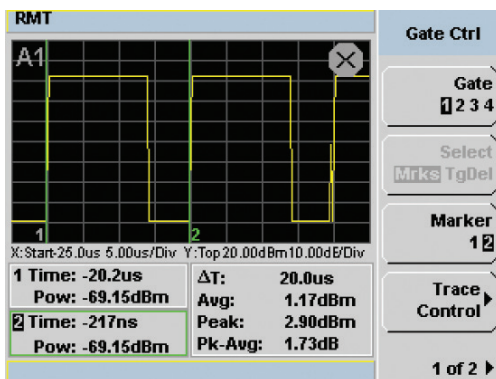

Peak and Average Power Measurements For Effective Capture of Wireless Signals (continued)

Wide video bandwidth for MCPA testing

In designing multi-carrier power amplifiers (MCPA), a wide-bandwidth power meter such as the P-Series helps you ensure that your device stays within its maximum power specification. The P-Series power meter's 30 MHz video bandwidth allows up to six 3G carriers over a wide dynamic range.

- CCDF and peak-to-average power measurements verify if MCPA is clipping
- 100 MSamples/s continuous sampling ensures easier detection of glitches
- Rise/fall time measurements help in checking the signal's burst profile and in identifying power transition problems
- High resolution color display ease viewing and differentiation of the four traces

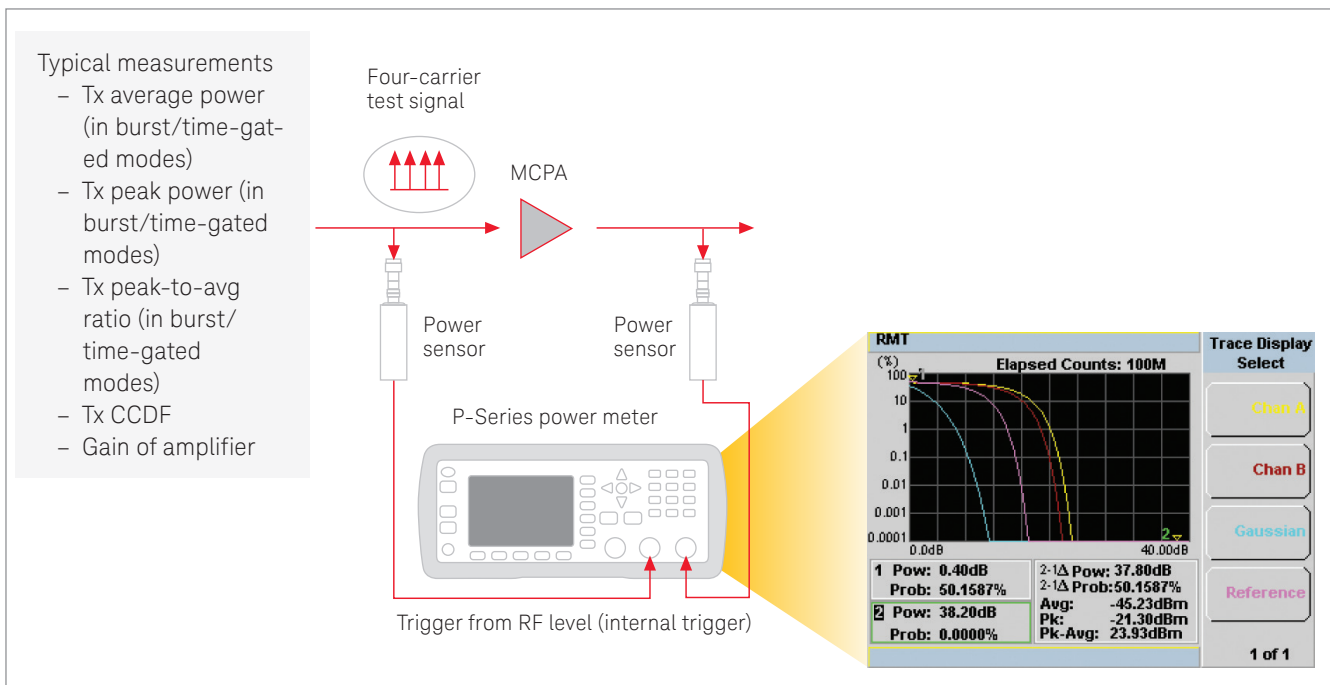

A sample setup for MCPA testing

Peak and Average Power Measurements For Effective Capture of Wireless Signals (continued)

i The P-Series power sensors' internal zeroing and calibration

- Integrates DC reference source and switching circuits into sensor
- Eliminates the need for calibration with an external reference source
- Eliminates the need to connect/disconnect from calibration source and test fixtures
- Reduces test times, measurement uncertainty and wear-and-tear on connectors

Compatible power sensors/software



P-Series power sensors (50 MHz to 40 GHz; -35 dBm to +20 dBm)



E9320 E-Series power sensors (50 MHz to 18 GHz; -65 dBm to +20 dBm)¹



E4410 and E9300 E-Series power sensors (9 kHz to 26.5 GHz; -70 dBm to +44 dBm)



N8480 Series thermocouple and waveguide power sensors (100 kHz to 67 GHz; -35 dBm to +44 dBm)



8480 Series diode, thermocouple and waveguide power sensors (100 kHz to 110 GHz; -70 dBm to +20 dBm)¹



N1918A Power Analysis Manager software



BenchVue software (version 3.0 and above)

Frequency and power ranges are wider with options. Please visit our Web site at www.keysight.com/find/powermeters to find out the options available for each sensor.

1. N1917x cables are required to connect 8480/E9300 E-Series power sensors to the N1911A/12A P-Series power meters. For more details, refer to the Configuration Guide (5989-1252EN)

Peak and Average Power Measurements For Testing of Complex Modulation Formats

Keysight E4416A/17A EPM-P Series power meters

The EPM-P Series power meters operate with the E9320 Series peak-and-average power sensors for testing various complex modulation formats in wireless communication systems, such as TDMA and CDMA.

Features

Models

- Single-channel E4416A
- Dual-channel E4417A

Specifications

- 5 MHz video bandwidth
- 20 Msamples/s continuous sampling rate

Measurement type

- Peak, average, peak-to-average ratio power measurements
- Time-gated and free-run measurement modes
- Includes predefined configurations for GSM, EDGE, NADC, iDEN, *Bluetooth*[®], IS-95 CDMA, W-CDMA and cdma2000[®]

Calibration

- Calibration and correction factors in EEPROM (E-Series sensors and N8480 Series)

Remote programmability

- SCPI standard interface commands
- GPIB, RS-232/422 interfaces

System-ready software

- EPM-P analyzer software

Backward-compatibility

- Code-compatible with EPM Series power meters

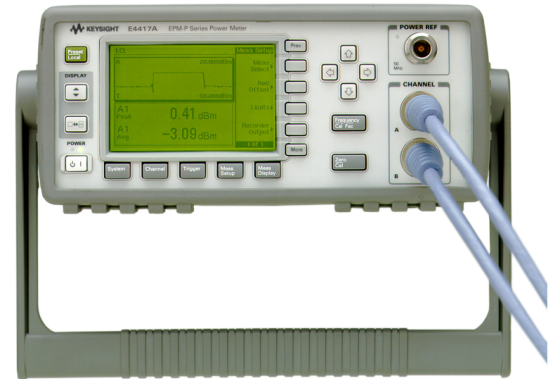

Highlights

- Optimize dynamic range for peak power measurement
- Complete TDMA and CDMA characterization

Peak and Average Power Measurements For Testing of Complex Modulation Formats (continued)

Optimize dynamic range with E9320 Series sensors

Wider bandwidths allow you to profile fast-changing signals, but at the expense of dynamic range. That's why each E9320 Series power sensor comes with three variable bandwidth settings. This helps you select the best bandwidth for your application, yet still maintain the widest possible dynamic range.

Sensor model	Video bandwidth/maximum peak power dynamic range			
	Off	High	Medium	Low
E9321A	300 kHz/	300 kHz/	100 kHz/	30 kHz/
E9325A	-40 dBm to +20 dBm	-42 dBm to +20 dBm	-43 dBm to +20 dBm	-45 dBm to +20 dBm
E9322A	1.5 MHz/	1.5 MHz/	300 kHz/	100 kHz/
E9326A	-36 dBm to +20 dBm	-37 dBm to +20 dBm	-38 dBm to +20 dBm	-39 dBm to +20 dBm
E9323A	5 MHz/	5 MHz/	1.5 MHz/	300 kHz/
E9327A	-32 dBm to +20 dBm	-32 dBm to +20 dBm	-34 dBm to +20 dBm	-36 dBm to +20 dBm

Complete TDMA/CDMA analysis with bundled analyzer software

Pulse analysis

Versatile markers offer complete power and timing characterization of pulsed signals, to provide easy testing of TDMA component parameters and system performance. In addition to measuring peak, average and peak-to-average ratio power, the Keysight EPM-P analyzer software measures the following pulse characteristics automatically:



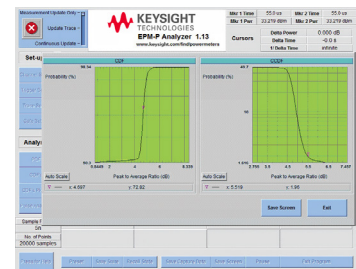
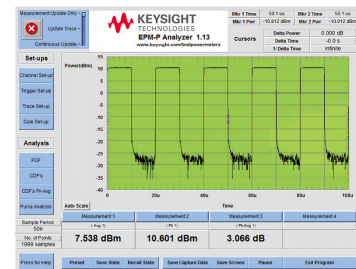

- Power: pulse top, pulse base, distal, mesial, proximal, overshoot and burst average
- Frequency and time: Pulse Repetition Frequency (PRF), Pulse Repetition Interval (PRI), pulse width, off-time, rise time and fall time



Statistical analysis

For today's noise-like CDMA and W-CDMA formats, statistical analysis of the power distribution helps you optimize system design by providing essential characterizations such as amplifier compression. The Keysight EPM-P analyzer software provides the capability to determine the PDF, CDF and CCDF.

Compatible power sensors/software

	E9320 E-Series power sensors (50 MHz to 18 GHz; -65 dBm to +20 dBm)
	E4410 and E9300 E-Series power sensors (9 kHz to 26.5 GHz; -70 dBm to +44 dBm)
	N8480 Series thermocouple and waveguide power sensors (100 kHz to 67 GHz; -35 dBm to +44 dBm)
	8480 Series diode, thermocouple and waveguide power sensors (100 kHz to 110 GHz; -70 dBm to +20 dBm)

Frequency and power ranges are wider with options. Please visit our Web site at www.keysight.com/find/powermeters to find out the options available for each sensor.

Peak and Average Power Measurements For Testing of Complex Modulation Formats (continued)

EPM-P analyzer software

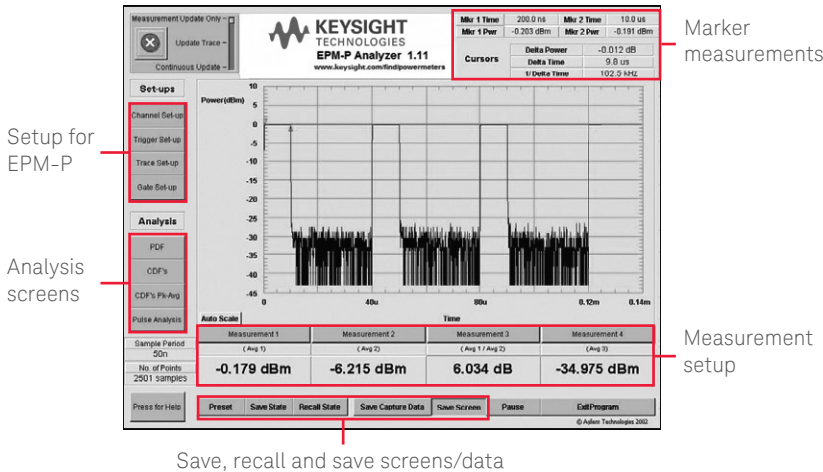

Setups for EPM-P

This software controls the power meter and is used to set up the Channel, Trigger and Gate Setups as shown through the front panel.

Analysis screens

After the power meter is configured, the trace is captured to allow for analysis of the captured trace data. There are various analysis screens covering statistical analysis such as Probability Density Function (PDF) and Complementary Cumulative Distribution Function (CCDF or 1-CDF) measurements and pulse analysis.

Marker measurements

When the trace is captured, the marker measurements can be used to provide time and power information, and the trace can also be zoomed in to look closely at areas of interest.

Measurement setup

The display can show up to four real-time power measurements, which are configured in a similar manner to the power meter display, and allows time-gated average, peak, peak-to-average ratio measurements, as well as combination measurements to be displayed.

Save, recall and save screens/data

If the analyzer display is required for reports or import into other applications, the screen can be saved as a JPG or BMP file and the power and time data from the captured trace can also be saved in a CSV file. The analyzer software allows 10 states to be stored and recalled. This ensures easy set up of the analyzer software and allows repeatable measurements to be obtained. These states are saved in a separate file, and stored on the PC or a disc, ensuring users on different PCs are operating the same setups and therefore making the same measurements.

Average Power Measurements For Metrology and Calibration Laboratories

Keysight N432A thermistor power meter

The N432A is a single-channel, average RF power meter that's ideal for high-accuracy measurement applications, particularly metrology and calibration laboratory environments.

Features

Measurement type

- Average power measurements

Calibration

- Built-in calibration factor table

Remote programmability

- SCPI standard interface commands

Highly accurate RF measurements for metrology and calibration

The N432A's high 0.2% accuracy, coupled with Keysight 478A-H75/H76 thermistor sensors, makes it excellent for 1 mW transfer calibration.



Highlights

- High accuracy ($\leq 0.2\%$
 $\pm 0.5 \mu\text{W}$)
- Built-in 6.5-digit ADC eliminates the need for an external DMM
- DC substitution measurement, traceable to the U.S. National Institute of Standards and Technology (NIST)
- Selectable bridge resistance
- Digital color LCD display, and user-friendly interface

Compatible power sensors/software



478A coaxial thermistor mount power sensor (10 MHz to 10 GHz; -30 dBm to +10 dBm)



8478B coaxial thermistor mount power sensor (10 MHz to 18 GHz; -30 dBm to +10 dBm)

Frequency and power ranges are wider with options. Please visit our Web site at www.keysight.com/find/powermeters to find out the options available for each sensor.

Average Power Measurements For Flexible Testing: On the Rack and On the Go

Keysight N1913A/14A EPM Series power meters

The Keysight N1913A/14A EPM Series power meters are versatile, user-friendly replacements for the popular E4418B/19B EPM power meters. They deliver fast, repeatable, reliable results for both bench/rack and field applications.

Features

Models

- Single-channel N1913A
 - Dual-channel N1914A
- Note: Two optional USB channels available for purchase*

Measurement type

- Average power measurements

Calibration

- Calibration and correction factors in EEPROM (E-Series and N8480 Series)

Remote programmability

- SCPI standard interface commands
- GPIB, USB and LAN/LXI-C interfaces

Backward-compatibility

- Code-compatible with legacy E4418B/9B EPM Series, 436A, 437B and 438A power meters (43X compatibility only with Option N191xA-200)



Highlights

- Up to four-channel power measurements
- Fast measurement speed of 400 readings/second
- Industry's first color LCD screen in an average power meter
- Convenient field usage with operating case and battery option
- Optional external trigger feature for automatic frequency/power sweep measurements
- VGA output option for connection to external monitor

Average Power Measurements For Flexible Testing: On the Rack and On the Go (continued)

View measurements better in any lighting and angle

The new EPM Series come with the industry's first color LCD in an average power meter. With its high-resolution color and wide viewing angle, you can see your test results more easily—no matter where you are.

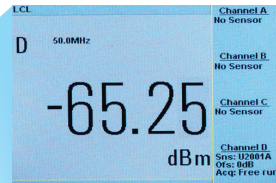
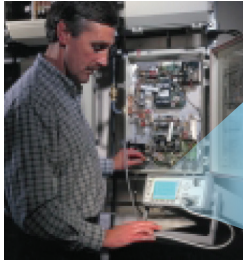

Perform field measurements conveniently

You can easily carry an EPM Series power meter in its operating case when you need to travel between stations. This meter is also available with a battery option and one-button battery power level check so you can keep your power meters at its optimum capacity before your next field task. To ensure continuous power, you can opt for a spare battery pack (Option N191xA-300).



Compatible power sensors/software



U2000 Series USB power sensors (9 kHz to 24 GHz; -60 dBm to +44 dBm)



E4410 and E9300 E-Series power sensors (9 kHz to 26.5 GHz; -70 dBm to +44 dBm)



N8480 Series thermocouple and waveguide power sensors (100 kHz to 67 GHz; -35 dBm to +44 dBm)



8480 Series diode, thermocouple and waveguide power sensors (100 kHz to 110 GHz; -70 dBm to +20 dBm)



BenchVue software (version 3.0 and above)

Frequency and power ranges are wider with options. Please visit our Web site at www.keysight.com/find/powermeters to find out the options available for each sensor.

Average Power Measurements For Mobile Testing that's Plug-and-Play Easy

Keysight U2000 Series USB power sensors

Standalone USB-based U2000 Series power sensors enable power measurements without power meters. Using USB power and providing built-in triggering, these power sensors don't need external power adapters or triggering modules for synchronization with external instruments or events. All these make the U2000 Series an ideal choice for high performance mobile power measurements.

Features

Measurement type

- Average power measurements
- Frequency range: 9 kHz to 24 GHz
- Dynamic range: -60 dBm to 44 dBm

Remote programmability

- USB interface

System-ready software

- N1918A Power Analysis Manager software

Backward-compatibility

- Code-compatible with E4418B EPM Series power meter

Highlights

- Travel with lighter-weight instruments
- Set-up easily with USB, and measure from practically anywhere beyond USB cable length
- Save time connecting/disconnecting sensor with internal zeroing
- RF burst signal measurement with time-gating
- Built-in internal triggering and trace graph display

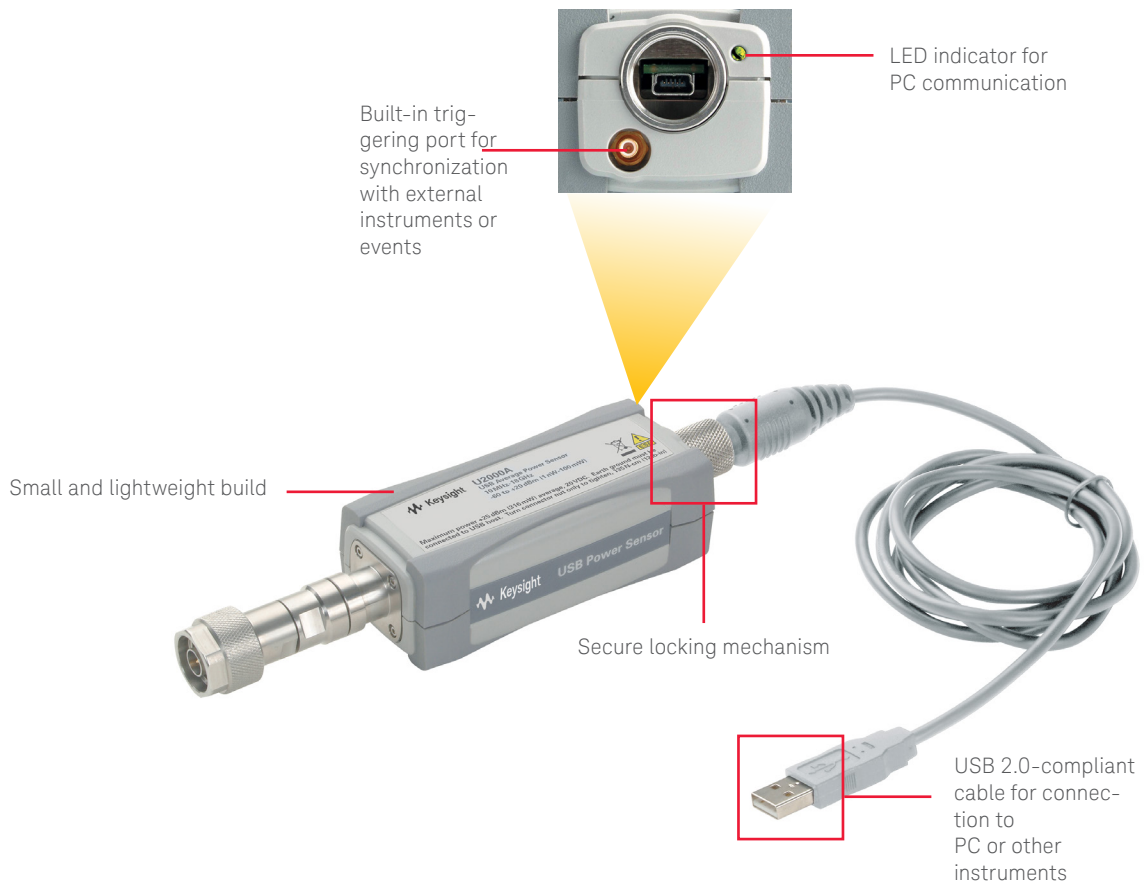

Average Power Measurements For Mobile Testing that's Plug-and-Play Easy (continued)

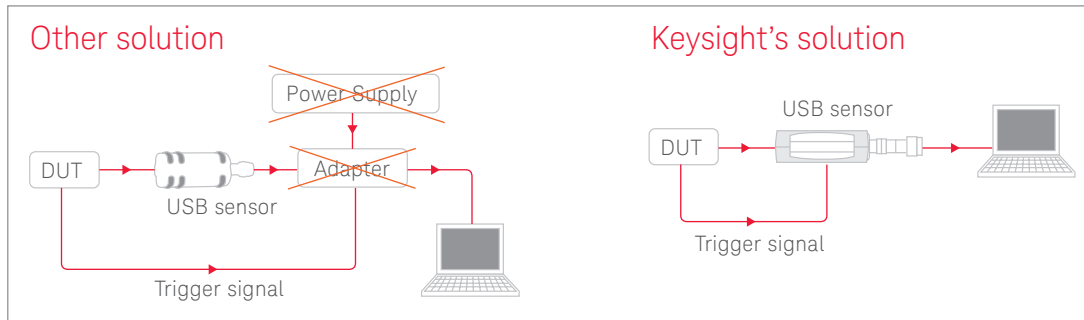

A U2000 USB power sensor's setup is simple, unlike the complicated setup of other USB-based power measurement solutions

Perform antenna testing across any distance

When a U2000 Series sensor's USB cable is connected to a USB-to-LAN hub, you can perform measurements beyond the limits of USB cable length. Conveniently leave your sensor connected to the power tap-off—even while performing zeroing – and monitor your measurements remotely.

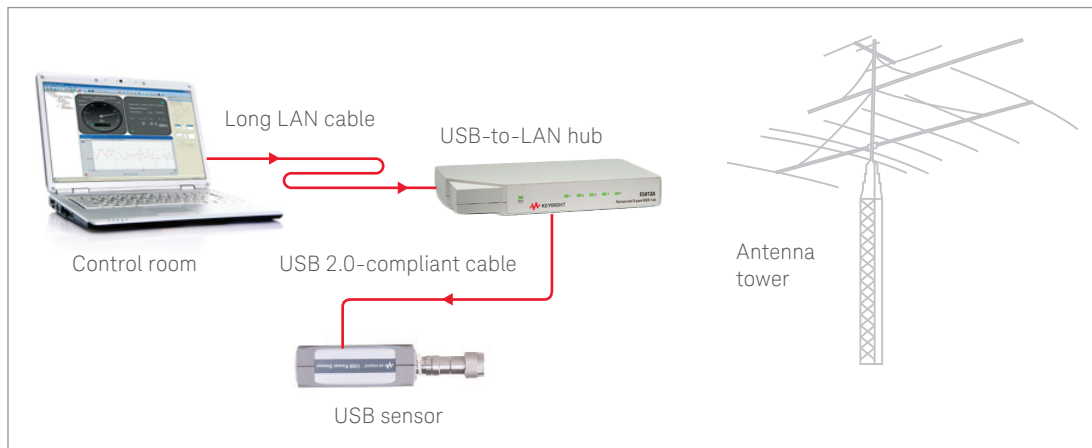

Perform base station testing without the usual bulkiness

When you need to take power measurements on the road or up a base station tower, smaller, lighter and fewer is better. With the U2000 Series USB power sensors, the only other thing you'll need is a laptop with the N1918A Power Analysis Manager or BenchVue software installed.

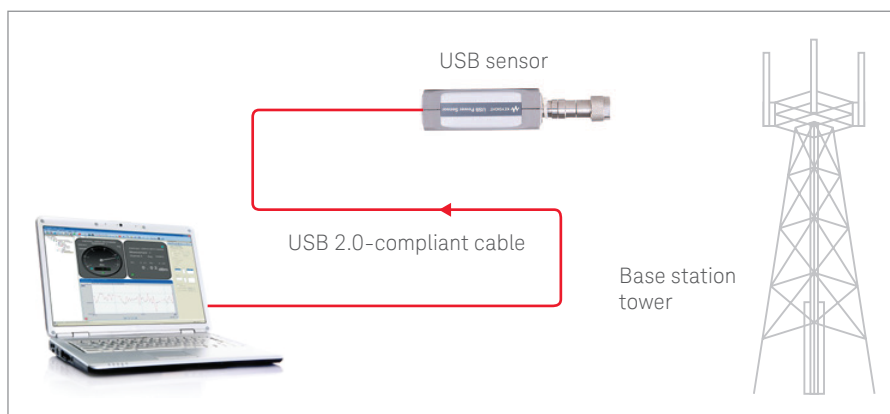

Average Power Measurements For Mobile Testing that's Plug-and-Play Easy (continued)

Reduce sensor connection/disconnection

With a U2000 Series sensor's internal zeroing capability, you don't need to power off the device-under-test or disconnect the sensor. This saves test time and reduces sensor wear-and-tear – advantages that are especially crucial in applications where every second counts, such as manufacturing test. With internal zeroing, the sensor can be left connected to the test fixture.



View multiple display formats, set limits and alerts, and more...

The N1918A Power Analysis Manager or BenchVue software displays measurements with the U2000 Series power sensors. Besides monitoring signals, this feature-packed software also enables further analysis through functions such as time-gated capability, autoscaling, zooming, record and save capabilities.

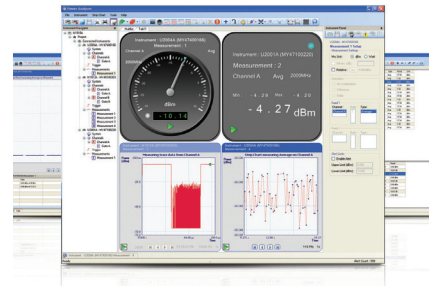

Add power measurements to other instruments

Sometimes you may want to perform accurate average power measurements with a Keysight network analyzer or spectrum analyzer. You could literally have a power meter next to you – or instead, turn select Keysight instruments into power meters with the U2000 Series. Even with the U2000 connected, you can switch between power measurements and the instrument's original function at any time.



Compatible power sensors/software



N1918A Power Analysis Manager software



BenchVue software (version 3.0 and above)

Average Power Measurements For Improved Power Measurement Throughput

Keysight U8480 Series USB thermocouple power sensors

The U8480 Series USB power sensor is one of the most cost-effective solutions in Keysight's power meter and sensor portfolio, providing top performance features at costs so affordable that every engineer can carry one in their bags. These sensors come with a measurement speed of 900 readings/second and power linearity of less than 0.8%, providing high accuracy and stability to help you make average power measurements from DC to 67 GHz (sensor dependent) quickly and confidently.

Features

Models

- U8481A USB thermocouple power sensor (DC/10 MHz to 18 GHz; -35 dBm to +20 dBm)
- U8485A USB thermocouple power sensor (DC/10 MHz to 33 GHz; -35 dBm to +20 dBm)
- U8487A USB thermocouple power sensor (10 MHz to 50 GHz; -35 dBm to +20 dBm)
- U8488A USB thermocouple power sensor (10 MHz to 67 GHz; -35 dBm to +20 dBm)

Specifications

- 900 readings/s measurement speed
- Power linearity: < 0.55% (-1 to +15 dBm); < 0.80% (+15 to +30 dBm)
- Damage level (RF): 25 dBm (average power); 15 W (2 μ s duration) (peak power)
- Damage level (DC): AC coupled (option 100), 50 V; DC coupled (option 200), 4 V
- Zero set: < 25 nW
- Zero drift: < 10 nW
- Measurement noise: < 80 nW

Measurement type

- Average power measurements

Calibration

- Internal calibration

Remote programmability

- USB interface



Highlights

- Measurement speed of 900 readings/second and power linearity of < 0.8%
- Keysight's first power sensor to measure down to DC (sensor dependent)
- Add power measurement capabilities to selected Keysight instruments, and switch between power measurements and the instrument's original function when needed
- Improve accuracy with real time measurement uncertainty feature
- Correct for errors with the S-parameter and gamma correction functions

Average Power Measurements For Improved Power Measurement Throughput (continued)

Continuous remote monitoring of satellite communication systems

Many satellite communication systems operate at microwave frequencies such as X, Ku and Ka bands, which supports wider modulation bandwidth, increased capacity and enables the use of smaller antennas. The U8480 Series covers a wide frequency range from DC to 67 GHz (sensor dependent), and can test satellites up to Ku or Ka bands. The USB sensors also come with a built-in DC reference source and excellent long term drift performance and can be left connected to a test setup without human intervention for several months, making the U8480 Series an ideal solution for long term, remote monitoring of satellite communication systems.

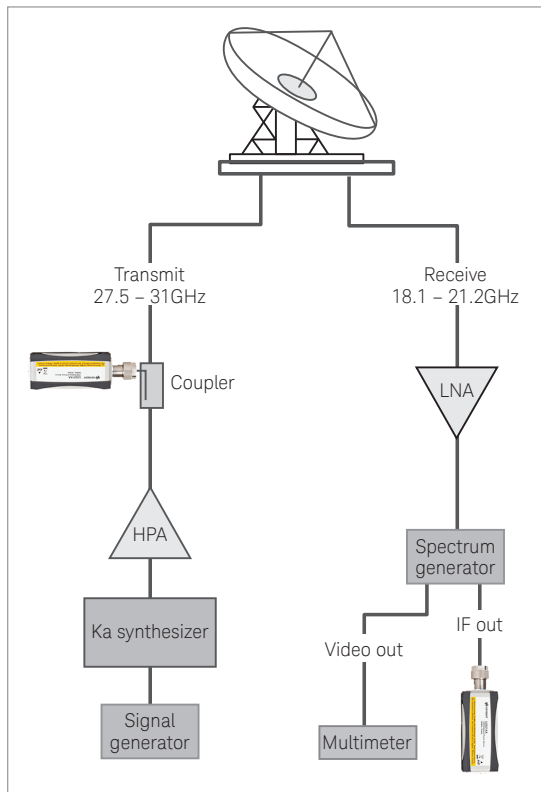

Typical satellite test system set-up

Perform measurement/calibration down to DC range

The U8481A and U8485A USB thermocouple sensors have the ability to perform measurements down to the DC range, which is often used for source calibration and power measurement reference for Keysight instruments such as the PNA/PNA-X network analyzers and the MXG X-Series signal generators. DC range measurements are also applicable to some EMC applications.

Compatible power sensors/software



N1918A Power Analysis Manager software



BenchVue software (version 3.0 and above)

Average Power Measurements For Portable RF Measurements

Keysight V3500A handheld RF power meter

The V3500A is a portable, palm-sized power meter with an integrated power sensor and built-in display. Compact with essential average power measurement capabilities, the V3500A is a handy tool for installation and maintenance or R&D lab environments.

Features

Measurement type

- Average power measurements
- Frequency range: 10 MHz to 6 GHz
- Dynamic range: -60 dBm to 20 dBm

Remote programmability

- Programming languages: Microsoft Visual Studio.NET, Microsoft Visual Basic, and Microsoft Visual C++
- USB interface

Truly portable for field measurements

The V3500A provides an optional loop holster carrying case with a shoulder strap. The handheld comes with a backlit display and illuminated keypad to help you make measurements in poorly lit conditions.



Highlights

- Small and lightweight form that fits in your palm, no separate power sensor or display needed
- Internal power reference enables self-calibration
- Absolute accuracy up to ± 0.21 dB
- Multiple power-up methods: AA batteries, computer via USB interface, AC-DC converter module (Option PWR)

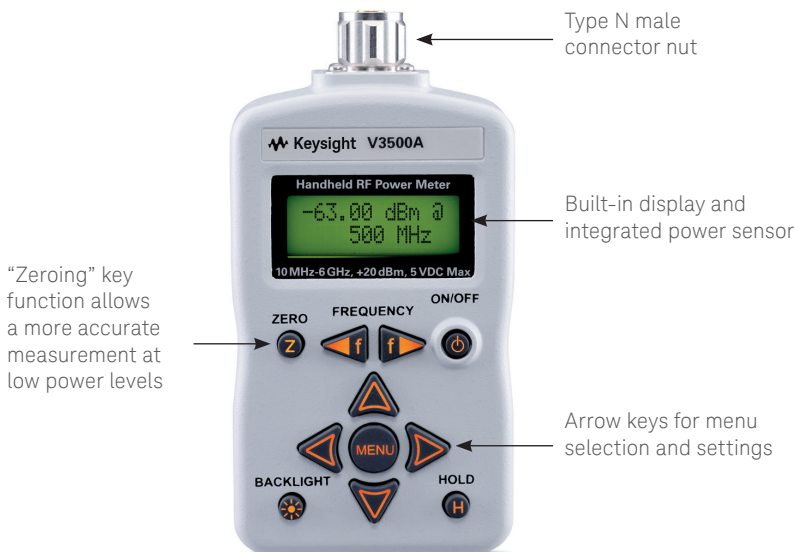

Power Measurement Software For Easy Monitoring and Troubleshooting

N1918A Power Analysis Manager

The N1918A Power Analysis Manager is compatible with the U2020 X-Series USB power sensors, U8480 Series USB thermocouple power sensors, U2000 Series USB power sensors, N1911/12A P-Series power meters and N8262A P-Series modular power meter. This feature-packed software not only enables performance monitoring and data collection, but also simplifies post-data analysis and speeds up troubleshooting.

For more information on the N1918A Power Analysis Manager, visit www.keysight.com/find/N1918A.

Highlights

- Multiple viewing types, including multiple-channel list (> 20 channels)
- Overlay trace graph and waveform mathematics for easy signals computation
- Record and save for easy troubleshooting
- Limit and alert settings for multiple channels monitoring
- Complete 15-point pulse characterization for peak power analysis
- PDF, CDF and CCDF tables and graphs for statistical analysis

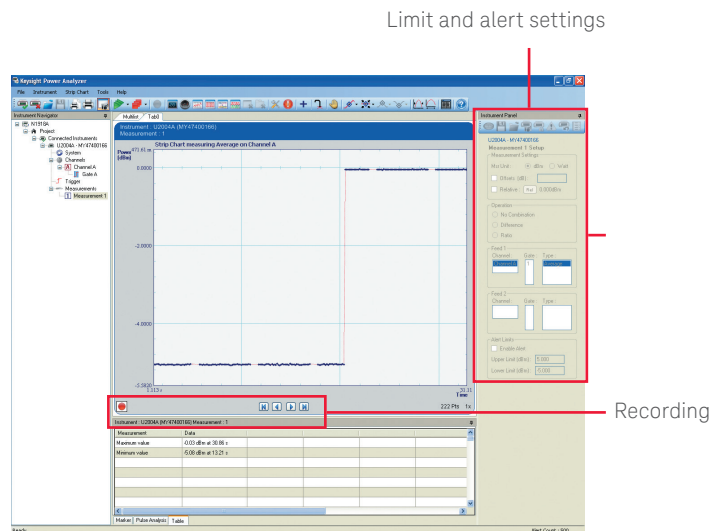
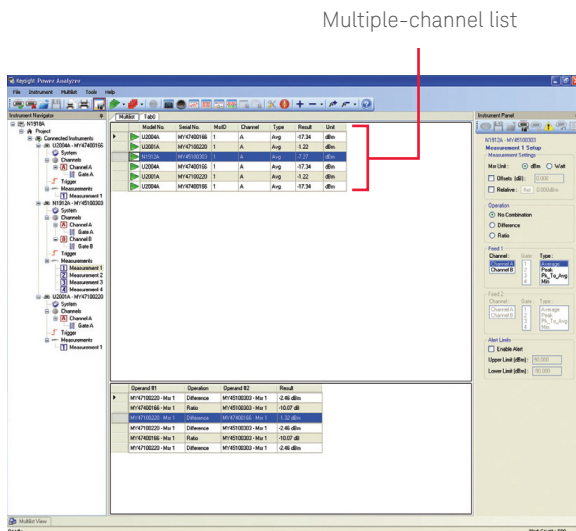
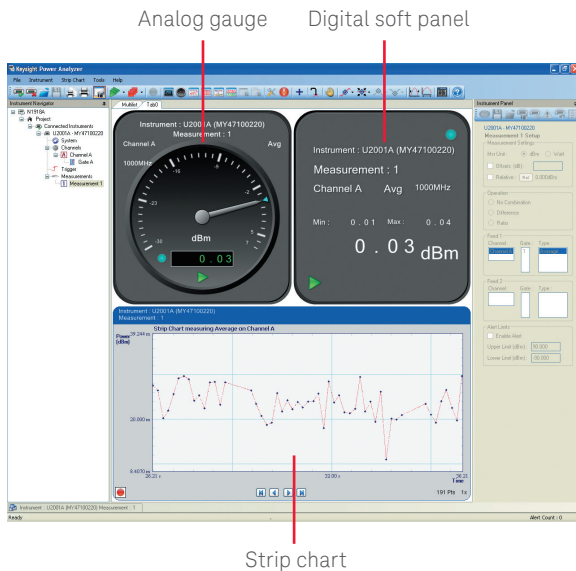

Power Measurement Software For Simplified Data Capture

BenchVue software

The Keysight BenchVue software for the PC accelerates testing by providing intuitive, multi instrument measurement visibility and data capture with no programming necessary. You can derive answers faster than ever by easily viewing, capturing and exporting measurement data and screenshots.

For more information on the BenchVue software, visit www.keysight.com/find/BenchVue.

Highlights

- Visualize multiple measurements simultaneously
- Easily log data, screen images and system state
- Recall past state of your bench to replicate results
- Fast measurement data export in desired formats
- Quickly access manuals, drivers, FAQs and videos
- Monitor and control your bench from mobile devices
- Compatible with the following power meter and sensor models: N1911A/12A P-Series power meters, N1913A/14A EPM Series power meters, N8262A P-Series modular power meter, U2000 Series USB power sensors, U8480 Series USB thermocouple power sensors, U2020 X-Series USB power sensors and U2040 X-Series wide dynamic range power sensors

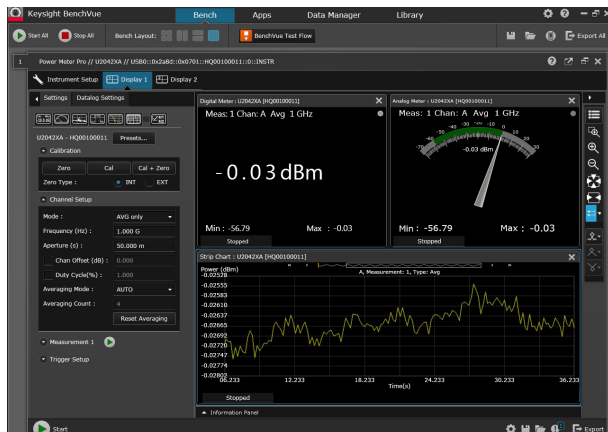

Digital meter, analog meter and datalog view

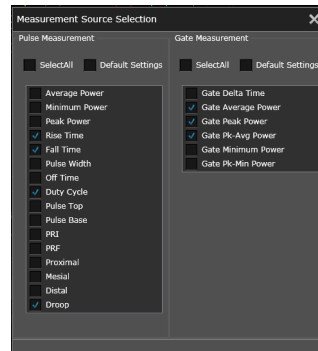



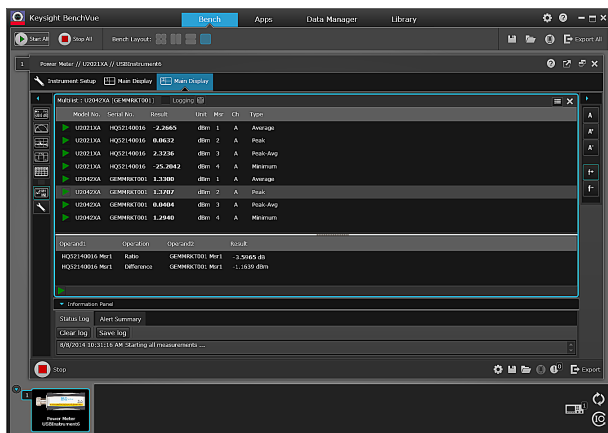







Multi-channel trace display with 4-pairs of gates and automatic pulse parameters measurement



Multi-list view with ratio/difference function

Power Meters Selection Chart for Wireless Communication

Peak Power Measurement	Power Sensor Options	Average Power Measurement	Power Sensor Options
EPM-P E4416A/17A (VBW: 5 MHz) 	- E932x Peak-and-Average Sensors (300 kHz, 1.5 MHz, 5 MHz) * Also compatible with all average power sensors	EPM N1913A/14A 	- 848x Diode and Thermocouple Sensors - N848x Thermocouple Sensors - N848x and 848x Waveguide Sensors - E441x 1-Path Diode CW-only Sensors - E930x 2-Path Diode True-Average Sensors - U200x USB Sensors
P-Series N1911A/12A (VBW: 30 MHz) 	For the P-series meters - N1921A/22A Wideband Sensors (30 MHz) - E932x Peak-and-Average Sensors (300 kHz, 1.5 MHz, 5 MHz)		
U2020 X-Series USB power sensors (VBW: 30 MHz) 		N432A Thermistor power meter 	- 478A Thermistor Sensor - 8478B Thermistor Sensor
P-Series modular N8262A (VBW: 30 MHz) 	* Also compatible with all average power sensors	U8480 Series USB thermocouple sensors 	
U2040 X-Series power sensors (VBW: 5 MHz) 	For the 8990B - N1923A/24A Wideband Sensors (150 MHz) - N1921A/22A Wideband Sensors (30 MHz)	U2000 Serie USB power sensors 	
8990B peak power analyzer (VBW: 150 MHz) 		V3500A handheld RF power meter 	

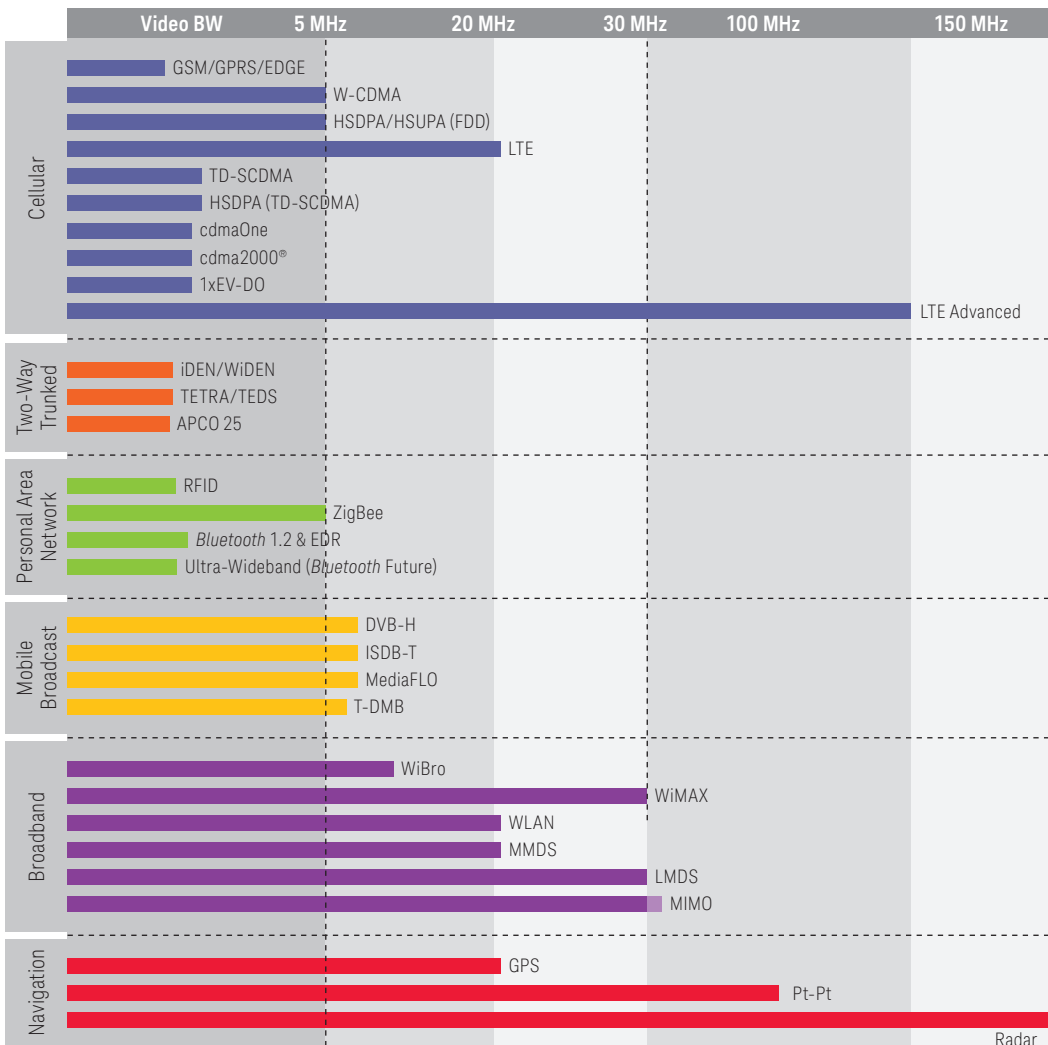

Power Sensors Selection Chart for Wireless Communication

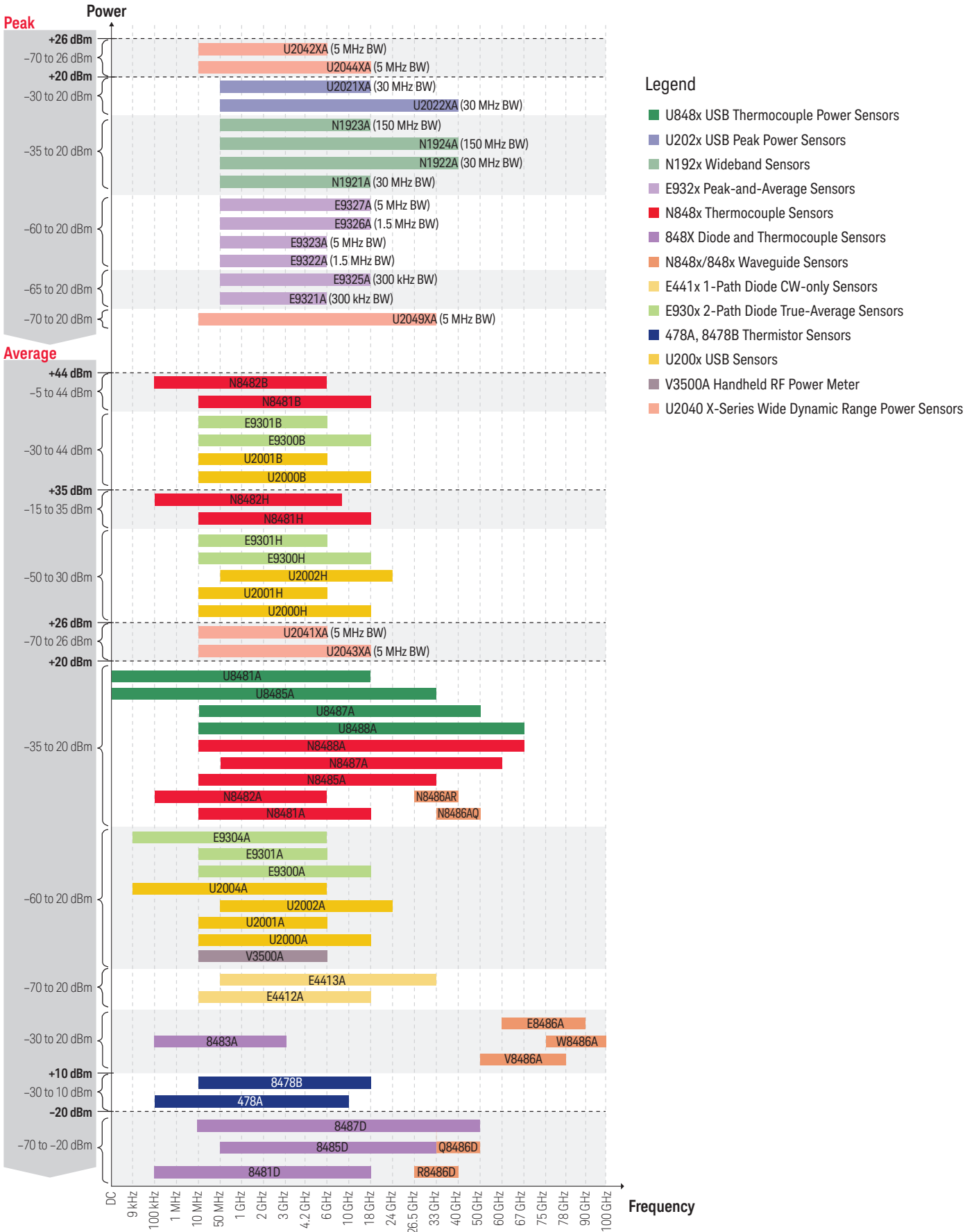

Power Meters and Sensors Compatibility Table

	POWER METERS							Product Description/ Sensor Tech.	Frequency Range	Power Range
	N432A/432A ¹	E4416A/17A EPM-P	N1913A/14A E4418B/19B EPM ²	E1416A VKI	N1911A/12A N8262A P-Series	8990B				
U2040 X-Series wide dynamic range power sensors	U2041XA	-	-	-	-	-	√ ³	Diode Power Sensor	10 MHz to 6 GHz	-70 dBm (100 pW) to +26 dBm (398 mW)
	U2042XA	-	-	-	-	-	√ ³	Diode Power Sensor	10 MHz to 6 GHz	-70 dBm (100 pW) to +26 dBm (398 mW)
	U2043XA	-	-	-	-	-	√ ³	Diode Power Sensor	10 MHz to 18 GHz	-70 dBm (100 pW) to +26 dBm (398 mW)
	U2044XA	-	-	-	-	-	√ ³	Diode Power Sensor	10 MHz to 18 GHz	-70 dBm (100 pW) to +26 dBm (398 mW)
	U2049XA	-	-	-	-	-	-	Diode Power Sensor	10 MHz to 33 GHz	-70 dBm (100 pW) to +20 dBm (100 mW)
U8480 Series USB thermocouple sensors	U8481A	-	-	√ ⁴	-	-	√ ^{3.5}	Thermocouple Power Sensor	DC/10 MHz to 18 GHz	-35 dBm (316 nW) to +20 dBm (100 mW)
	U8485A	-	-	√ ⁴	-	-	√ ^{3.5}	Thermocouple Power Sensor	DC/10 MHz to 33 GHz	-35 dBm (316 nW) to +20 dBm (100 mW)
	U8487A	-	-	√ ⁴	-	-	√ ^{3.5}	Thermocouple Power Sensor	10 MHz to 50 GHz	-35 dBm (316 nW) to +20 dBm (100 mW)
	U8488A	-	-	√ ⁴	-	-	√ ^{3.5}	Thermocouple Power Sensor	10 MHz to 67 GHz	-35 dBm (316 nW) to +20 dBm (100 mW)
U2020 X-Series USB sensors	U2021XA	-	-	-	-	-	√ ^{3.5}	Diode Power Sensor	50 MHz to 18 GHz	-35 dBm (316 nW) to +20 dBm (100 mW)
	U2022XA	-	-	-	-	-	√ ^{3.5}	Diode Power Sensor	50 MHz to 40 GHz	-35 dBm (316 nW) to +20 dBm (100 mW)
Wideband power sensors	N1923A	-	-	-	-	-	√	Diode Power Sensor	50 MHz to 18 GHz	-35 dBm (316 nW) to +20 dBm (100 mW)
	N1924A	-	-	-	-	-	√	Diode Power Sensor	50 MHz to 40 GHz	-35 dBm (316 nW) to +20 dBm (100 mW)
P-Series Wideband sensors	N1921A	-	-	-	-	√	√	Diode Power Sensor	50 MHz to 18 GHz	-35 dBm (316 nW) to +20 dBm (100 mW)
	N1922A	-	-	-	-	√	√	Diode Power Sensor	50 MHz to 40 GHz	-35 dBm (316 nW) to +20 dBm (100 mW)
E-Series Peak-and-Average sensors	E9321A	-	√	-	-	√	-	Diode Power Sensor	50 MHz to 6 GHz	-65 dBm (320 pW) to +20 dBm (100 mW)
	E9322A	-	√	-	-	√	-	Diode Power Sensor	50 MHz to 6 GHz	-60 dBm (1 nW) to +20 dBm (100 mW)
	E9323A	-	√	-	-	√	-	Diode Power Sensor	50 MHz to 6 GHz	-60 dBm (1 nW) to +20 dBm (100 mW)
	E9325A	-	√	-	-	√	-	Diode Power Sensor	50 MHz to 18 GHz	-65 dBm (320 pW) to +20 dBm (100 mW)
	E9326A	-	√	-	-	√	-	Diode Power Sensor	50 MHz to 18 GHz	-60 dBm (1 nW) to +20 dBm (100 mW)
	E9327A	-	√	-	-	√	-	Diode Power Sensor	50 MHz to 18 GHz	-60 dBm (1 nW) to +20 dBm (100 mW)
E-Series True Average sensors	E9300A	-	√	√	-	√	-	Diode Power Sensor	10 MHz to 18 GHz	-60 dBm (1 nW) to +20 dBm (100 mW)
	E9301A	-	√	√	-	√	-	Diode Power Sensor	10 MHz to 6 GHz	-60 dBm (1 nW) to +20 dBm (100 mW)
	E9304A	-	√	√	-	√	-	Diode Power Sensor	9 kHz to 6 GHz	-60 dBm (1 nW) to +20 dBm (100 mW)
	E9300B	-	√	√	-	√	-	Diode Power Sensor	10 MHz to 18 GHz	-30 dBm (1 μW) to +44 dBm (25 W)
	E9301B	-	√	√	-	√	-	Diode Power Sensor	10 MHz to 6 GHz	-30 dBm (1 μW) to +44 dBm (25 W)
	E9300H	-	√	√	-	√	-	Diode Power Sensor	10 MHz to 18 GHz	-50 dBm (10 nW) to +30 dBm (1 W)
E-Series CW-only sensors	E4412A	-	√	√	-	√	-	Diode Power Sensor	10 MHz to 18 GHz	-70 dBm (100 pW) to +20 dBm (100 mW)
	E4413A	-	√	√	-	√	-	Diode Power Sensor	50 MHz to 26.5 GHz	-70 dBm (100 pW) to +20 dBm (100 mW)
N8480 / 8480 Series Thermocouple and Diode sensors	N8481A	-	√	√	-	√	-	Thermocouple Power Sensor	10 MHz to 18 GHz	-35 dBm (316 nW) to +20 dBm (100 mW)
	N8482A	-	√	√	-	√	-	Thermocouple Power Sensor	100 kHz to 6 GHz	-35 dBm (316 nW) to +20 dBm (100 mW)
	8483A	-	√	√	√	√	-	Thermocouple Power Sensor	100 kHz to 2 GHz	-30 dBm (1 μW) to +20 dBm (100 mW)
	N8485A	-	√	√	-	√	-	Thermocouple Power Sensor	10 MHz to 26.5 GHz	-35 dBm (316 nW) to +20 dBm (100 mW)
	N8487A	-	√	√	-	√	-	Thermocouple Power Sensor	50 MHz to 50 GHz	-35 dBm (316 nW) to +20 dBm (100 mW)
	N8488A	-	√	√	-	√	-	Thermocouple Power Sensor	10 MHz to 67 GHz	-35 dBm (316 nW) to +20 dBm (100 mW)

1. The 432A model is superceded by the N432A.
2. The E4418B/19B models are superceded by the N1913A/14A.
3. Requires the BenchVue software (for U2020 X-Series, version 2.5 and above; for U2040 X-Series, version 2.6 and above; for U8480 Series and U2000 Series, version 3.0 and above).
4. Only with N1913A/14A.
5. Requires the N1918A Power Analysis Manager software.

* For the complete list of sensor options, please visit our Web site at www.keysight.com/find/powermeters.

Power Meters and Sensors Compatibility Table

		POWER METERS							Product Description / Sensor Tech.	Frequency Range	Power Range
		N432A/432A ¹	E4416A/17A EPM-P	N1913A/14A E4418B/19B EPM ²	E1416A VXI	N1911A/12A N8262A P-Series	8990B				
POWER SENSORS	N8480 / 8480 Series Thermocouple and Diode sensors	N8481B	-	√	√	-	√	-	High Power Thermocouple Sensor	10 MHz to 18 GHz	-5 dBm (316 μW) to +44 dBm (25 W)
		N8482B	-	√	√	-	√	-	High Power Thermocouple Sensor	100 kHz to 6 GHz	-5 dBm (316 μW) to +44 dBm (25 W)
		N8481H	-	√	√	-	√	-	High Power Thermocouple Sensor	10 MHz to 18 GHz	-15 dBm (32 μW) to +35 dBm (3 W)
		N8482H	-	√	√	-	√	-	High Power Thermocouple Sensor	100 kHz to 6 GHz	-15 dBm (32 μW) to +35 dBm (3 W)
		8481D	-	√	√	√	√	-	Diode Power Sensor	10 MHz to 18 GHz	-70 dBm (100 pW) to -20 dBm (10 μW)
		8485D	-	√	√	√	√	-	Diode Power Sensor	50 MHz to 26.5 GHz	-70 dBm (100 pW) to -20 dBm (10 μW)
		8487D	-	√	√	√	√	-	Diode Power Sensor	50 MHz to 50 GHz	-70 dBm (100 pW) to -20 dBm (10 μW)
	Waveguide sensors	R8486D	-	√	√	√	√	-	Waveguide Power Sensor	26.5 GHz to 40 GHz	-70 dBm (100 pW) to -20 dBm (10 μW)
		Q8486D	-	√	√	√	√	-	Waveguide Power Sensor	33 GHz to 50 GHz	-70 dBm (100 pW) to -20 dBm (10 μW)
		N8486AR	-	√	√	-	√	-	Thermocouple Waveguide Power Sensor	26.5 GHz to 40 GHz	-35 dBm (316 μW) to +20 dBm (100 mW)
		N8486AQ	-	√	√	-	√	-	Thermocouple Waveguide Power Sensor	33 GHz to 50 GHz	-35 dBm (316 μW) to +20 dBm (100 mW)
		V8486A	-	√	√	√	√	-	V-band Power Sensor	50 GHz to 75 GHz	-30 dBm (1 μW) to +20 dBm (100 mW)
		W8486A	-	√	√	√	√	-	Waveguide Power Sensor	75 GHz to 110 GHz	-30 dBm (1 μW) to +20 dBm (100 mW)
		E8486A	-	√	√	-	√	-	E-band Power Sensor	60 GHz to 90 GHz	-30 dBm (1 μW) to +20 dBm (100 mW)
	Thermistor mount sensors	478A	√	-	-	-	-	-	Coaxial Thermistor Mount	10 MHz to 10 GHz	-30 dBm (1 μW) to +10 dBm (10 mW)
		8478B	√	-	-	-	-	-	Coaxial Thermistor Mount	10 MHz to 18 GHz	-30 dBm (1 μW) to +10 dBm (10 mW)
	USB average sensors	U2000A	-	-	√ ³	-	-	√ ^{4,5}	Diode Power Sensor	10 MHz to 18 GHz	-60 dBm (1 nW) to +20 dBm (100 mW)
		U2001A	-	-	√ ³	-	-	√ ^{4,5}	Diode Power Sensor	10 MHz to 6 GHz	-60 dBm (1 nW) to +20 dBm (100 mW)
		U2002A	-	-	√ ³	-	-	√ ^{4,5}	Diode Power Sensor	50 MHz to 24 GHz	-60 dBm (1 nW) to +20 dBm (100 mW)
		U2004A	-	-	√ ³	-	-	√ ^{4,5}	Diode Power Sensor	9 kHz to 6 GHz	-60 dBm (1 nW) to +20 dBm (100 mW)
		U2000B	-	-	√ ³	-	-	√ ^{4,5}	Diode Power Sensor	10 MHz to 18 GHz	-30 dBm (1 μW) to +44 dBm (25 W)
		U2001B	-	-	√ ³	-	-	√ ^{4,5}	Diode Power Sensor	10 MHz to 6 GHz	-30 dBm (1 μW) to +44 dBm (25 W)
		U2000H	-	-	√ ³	-	-	√ ^{4,5}	Diode Power Sensor	10 MHz to 18 GHz	-50 dBm (10 nW) to +30 dBm (1 W)
		U2001H	-	-	√ ³	-	-	√ ^{4,5}	Diode Power Sensor	10 MHz to 6 GHz	-50 dBm (10 nW) to +30 dBm (1 W)
		U2002H	-	-	√ ³	-	-	√ ^{4,5}	Diode Power Sensor	50 MHz to 24 GHz	-50 dBm (10 nW) to +30 dBm (1 W)
	Discontinued 848x sensors	8481/2/5/7A	-	√	√	√	√	-	Thermocouple Power Sensor	100 kHz to 50 GHz	-30 dBm (1 μW) to +20 dBm (100 mW)
		848xB/H	-	√	√	√	√	-	High Power Thermocouple Sensor	100 kHz to 18 GHz	-10 dBm (100 μW) to +44 dBm (25 W)
		R8486A	-	√	√	√	√	-	Thermocouple Waveguide Power Sensor	26.5 GHz to 40 GHz	-30 dBm (1 μW) to +20 dBm (100 mW)
Q8486A		-	√	√	√	√	-	Thermocouple Waveguide Power Sensor	33 GHz to 50 GHz	-30 dBm (1 μW) to +20 dBm (100 mW)	

1. The 432A model is superseded by the N432A.
 2. The E4418B/19B models are superseded by the N1913A/14A.
 3. Only with N1913A/14A.
 4. Requires the N1918A Power Analysis Manager software.
 5. Requires the BenchVue software (for U2020 X-Series, version 2.5 and above; for U2040 X-Series, version 2.6 and above; for U8480 Series and U2000 Series, version 3.0 and above).

* For the complete list of sensor options, please visit our Web site at www.keysight.com/find/powermeters.

Free Power Measurement Hints and Tips

Keysight offers a wide selection of power meters and sensors for your application needs, and to help you make better measurements in less time, we've compiled an array of resources for you.

Visit the Power Measurement Hints and Tips page at www.keysight.com/find/rfpowertips for application notes, technical overviews and other power meter and sensor related tools.

Related Keysight Literature

Here are some key topics that may interest you:

Publication title	Publication number
<i>Long-Term, Remote Monitoring of Satellite Performance</i>	5991-3681EN
<i>Achieving Accurate E-band Power Measurements with Keysight E8486A Waveguide Power Sensors</i>	5991-3776EN
<i>An RF Power Measurement Solution for Multi-antenna MIMO Transmissions</i>	5991-3097EN
<i>Understanding DC-coupled and DC-blocked Power Sensors and How Your Choice of Sensor Would Impact Measurement Accuracy</i>	5990-6745EN
<i>MIMO Measurement Tips with Keysight P-Series Power Meters and U2000 Series USB Power Sensors</i>	5990-3546EN
<i>P-Series and EPM-P Power Meters for Bluetooth Testing</i>	5989-8459EN
<i>4 Steps for Making Better Power Measurements</i>	5965-8167E
<i>Choosing the Right Power Meter and Sensor</i>	5968-7150E

Watch a Live Demonstration or Video Introduction

Visit the Power Meter and Sensor playlist on the Keysight YouTube network at www.keysight.com/find/pmps-video to see the latest videos related to Keysight's power meter and sensor family.

Bluetooth and the Bluetooth logos are trademarks owned by Bluetooth SIG, Inc., U.S.A. and licensed to Keysight Technologies, Inc.

cdma2000 is a US registered certification mark of the Telecommunications Industry Association.

WiMAX, Mobile WiMAX, WiMAX Forum, the WiMAX Forum logo, WiMAX Forum Certified, and the WiMAX Forum Certified logo are US trademarks of the WiMAX Forum.

Evolving

Our unique combination of hardware, software, support, and people can help you reach your next breakthrough. **We are unlocking the future of technology.**

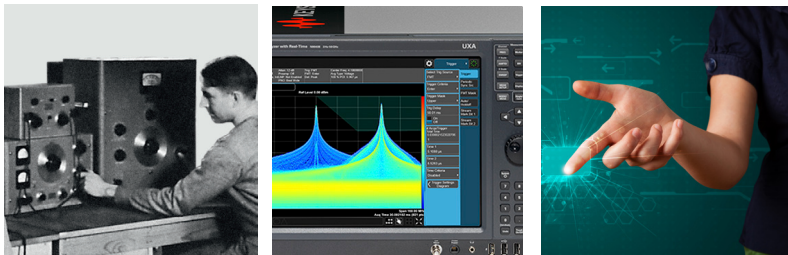

From Hewlett-Packard to Agilent to Keysight



myKeysight
myKeysight

www.keysight.com/find/mykeysight
A personalized view into the information most relevant to you.

Keysight Infoline
Keysight Infoline

Keysight Infoline
www.keysight.com/find/Infoline
Keysight's insight to best in class information management. Free access to your Keysight equipment company reports and e-library.

KEYSIGHT SERVICES

Keysight Services
www.keysight.com/find/services
Our deep offering in design, test, and measurement services deploys an industry-leading array of people, processes, and tools. The result? We help you implement new technologies and engineer improved processes that lower costs.



Three-Year Warranty
www.keysight.com/find/ThreeYearWarranty
Keysight's committed to superior product quality and lower total cost of ownership. Keysight is the only test and measurement company with three-year warranty standard on all instruments, worldwide. And, we provide a one-year warranty on many accessories, calibration devices, systems and custom products.



Keysight Assurance Plans
www.keysight.com/find/AssurancePlans
Up to ten years of protection and no budgetary surprises to ensure your instruments are operating to specification, so you can rely on accurate measurements.

Keysight Channel Partners
www.keysight.com/find/channelpartners
Get the best of both worlds: Keysight's measurement expertise and product breadth, combined with channel partner convenience.

www.keysight.com/find/powermeters

For more information on Keysight Technologies' products, applications or services, please contact your local Keysight office. The complete list is available at: www.keysight.com/find/contactus

Americas

Canada	(877) 894 4414
Brazil	55 11 3351 7010
Mexico	001 800 254 2440
United States	(800) 829 4444

Asia Pacific

Australia	1 800 629 485
China	800 810 0189
Hong Kong	800 938 693
India	1 800 11 2626
Japan	0120 (421) 345
Korea	080 769 0800
Malaysia	1 800 888 848
Singapore	1 800 375 8100
Taiwan	0800 047 866
Other AP Countries	(65) 6375 8100

Europe & Middle East

Austria	0800 001122
Belgium	0800 58580
Finland	0800 523252
France	0805 980333
Germany	0800 6270999
Ireland	1800 832700
Israel	1 809 343051
Italy	800 599100
Luxembourg	+32 800 58580
Netherlands	0800 0233200
Russia	8800 5009286
Spain	800 000154
Sweden	0200 882255
Switzerland	0800 805353
	Opt. 1 (DE)
	Opt. 2 (FR)
	Opt. 3 (IT)
United Kingdom	0800 0260637

For other unlisted countries:
www.keysight.com/find/contactus
(BP-06-08-16)



www.keysight.com/go/quality
Keysight Technologies, Inc.
DEKRA Certified ISO 9001:2015
Quality Management System